

E C A H O

European Conference of  
Arab Horse Organizations

**ECAHO**

**Judges Manual**

**2021**

**Pleasure Riding &**

**Driving & Trail &**

**Hand Trail Classes**

## **Arabian horse**

One of the world's oldest and purest breeds of light horse, the Arabian's ancestry is as far-reaching as civilization itself. Historical figures the likes of Genghis Khan, Napoleon, Alexander the Great and George Washington all rode Arabians. Originating in the harsh desert conditions of the Middle East, this compact, efficient breed with its unparalleled stamina, intelligence, hardiness, gentle disposition and loyalty evolved as a direct result of the unforgiving climate and became both a necessary instrument for survival and the most valued possession of its Bedouin master.

Designed for efficiency and longevity, Arabians are medium-sized (between 14.2 and 15.3 hands, 146 – 160 cm), short-coupled and possess a lean muscle mass. Their large lung capacity and efficient metabolism allow them to carry heavy load over great distances in extreme heat and with little water. In time, European horses were introduced to extensive infusion of the centuries-old pure Arabian blood when the heavy-boned sturdy war horses of the Middle Ages were replaced by light, swift and agile cavalry mounts possessing great endurance.

Given the Arabian was the original source of quality and speed, and remains foremost in the fields of endurance and soundness, the breed either directly or indirectly contributed to the formation of virtually all modern breeds of horses. In addition to essentially dominating the disciplines of endurance and competitive trail worldwide, the Arabian enjoys popularity across a wide range of disciplines, including English and Western pleasure, Cutting, Reining, Jumping, Dressage and Driving.

## Contents

|  |    |
|--|----|
| Judging .....                                  | 4  |
| Hints for Judging .....                        | 5  |
| Judge's card sample.....                       | 6  |
| PLEASURE.....                                  | 7  |
| Definition of „Pleasure“ .....                 | 7  |
| Description of main gaits .....                | 8  |
| WALK – 4-beat gait .....                       | 8  |
| TROT /JOG – 2-beat gait .....                  | 9  |
| LOPE / CANTER – 3-beat gait.....               | 11 |
| The Rein Back .....                            | 12 |
| The transitions .....                          | 12 |
| The Halt.....                                  | 13 |
| COMMON in all PLEASURE CLASSES .....           | 16 |
| CLASSIC PLEASURE .....                         | 17 |
| TRADITIONAL ARABIAN RIDING CLASS .....         | 19 |
| LADIES SIDE SADDLE .....                       | 21 |
| WESTERN PLEASURE .....                         | 26 |
| PLEASURE DRIVING .....                         | 29 |
| TRAIL Western & Classic & Hand Trail.....      | 32 |
| Illustrations .....                            | 43 |
| WESTERN BITS .....                             | 43 |
| CLASSIC SNAFFLES & BITS .....                  | 54 |
| Examples for Side Saddles:.....                | 59 |
| Buggy & Cart allowed in Pleasure Driving:..... | 60 |
| Notes: .....                                   | 62 |

**This Manual is based on the following rules and regulations:  
ECAHO Green Book, AQHA, FEI**

## Judging

Two or more judges on duty.

Well dressed, with long leaves and if they use a hat, fitting to either classic or western,

In case there are more than 20 competitors in a class, the class must be divided into groups. The 10 best of all groups start again for the ribbons in the final. A rider can only show one horse.

Judges should position themselves in quite a distance from one to another in the show arena. The show organizer should name one of the judges as the judge's chairman.

The judges should alternate on calling for the gaits. Therefore, a speaker standing close to the judge is necessary so that the competitors could hear the requested gaits clearly and misunderstandings can be avoided. There is no certain order of the gaits requested to be shown. They can as well be repeatedly requested.

Judges have to take care that the competition does not last too long (approx. 20 minutes). Therefore, there is not much time to judge each horse.

Backing shall be demanded on the centre line individually or in a small group! Standing still quietly is a must! Strong trot or hand gallop should not be asked in novice classes and Ladies Side Saddle classes.

Judging should take place under the following criteria:

- horse/rider is on pattern (no additional manoeuvres shown, elimination)
- correctness & quality of gaits
- manners & performance
- major/minor faults
- degree of difficulty
- the horse's suitability for the specific discipline

**Time out:** for technical problems during competition, In case of technical problems during the class the competitor can have maximum 5 minutes for repair. Has to stay in the ring. In Pleasure classes the other competitors walk on the rail . Maximum three competitors per class can have a timeout. If the problem cannot be solved in the five minutes the horse will be disqualified

Riders decide on which bit/snaffle they use for the competition, but must choose a bit/snaffle according to the specific rules. Using of Snaffle bit/Bit only in the correct way (Snaffle with two hands, Bit with one hand, Double Bridle with two hands)

**PROHIBITED ASSISTANCE.** If a contestant, while inside the show arena or show ring, is assisted in any manner by another person or provides assistance in any manner to another person, the contestant shall automatically be disqualified. Further more, this rule does not apply to a contestant who assists another contestant if such assistance was necessitated for the safety of competing exhibitors or horses as determined by the judge. However, the contestant in need of such assistance shall be disqualified

**Tails** lengthened by hair to hair attachment only with no attachments of any kind to the tailbone

If the show organizer offers All Around Titles all horses up to the 10<sup>th</sup> place must be ranked. Ribbons/Badges will be given in the following order: 6<sup>th</sup> place up to the 1<sup>st</sup>. Colours according to the Green Book.

## Hints for Judging

- Judges should be dressed appropriately.
- Agree that the show organizer named one of the judges as the judge's chairman in case of ties and announcing the gaits.
- Use a clipboard with a letter size page of paper
- Make sure the speaker is close to you
- List all the entry numbers as they enter the arena
- Quickly check on equipment not allowed
- Judging starts as soon as the riders enter the arena
- Pleasure classes: Divide your sheet into 3 sections (above average-average-below average)
- After the last rider has entered the arena "*class closed*" should be announced
- As you watch the horses performing the gaits rank them in one of these three groups
- All gaits must be shown on both hands!
- At the end of the competition find your individual ranking
- Fill in your judge's card and sign it
- Come up with your final result, sign it and handle it over to the Ringmaster. The final result will be done by the Showoffice. Do not speak with the other judges.
- Make sure that the show office will receive the individual placement. This should be organized by a ringmaster.

**Judge's card sample**  
**PLEASURE CLASSES**

**Show:** \_\_\_\_\_  
**Date:** \_\_\_\_\_  
**Class no:** \_\_\_\_\_  
**Class name:** \_\_\_\_\_  
**Ranking:**  
 1. \_\_\_\_\_ 9. \_\_\_\_\_  
 2. \_\_\_\_\_ 10. \_\_\_\_\_  
 3. \_\_\_\_\_ 11. \_\_\_\_\_  
 4. \_\_\_\_\_ 12. \_\_\_\_\_  
 5. \_\_\_\_\_ 13. \_\_\_\_\_  
 6. \_\_\_\_\_ 14. \_\_\_\_\_  
 7. \_\_\_\_\_ 15. \_\_\_\_\_  
 8. \_\_\_\_\_  
**Judge's name:** \_\_\_\_\_  
**Judge's signature:** \_\_\_\_\_  
**Entries in class:** \_\_\_\_\_

*For example:*

| <i>Entry no.</i> | <i>J1</i> | <i>J2</i> | <i>Total</i> | <i>Ranking</i> |
|------------------|-----------|-----------|--------------|----------------|
| 22               | 1         | 2         | 3            | 1. 22          |
| 5                | 2         | 4         | 6            | 2. 18          |
| 18               | 3         | 1         | 4            | 3. 5           |
| 46               | 4         | 3         | 7            | 4. 46          |

## PLEASURE

### Definition of „Pleasure“

In pleasure classes horses are shown in all gaits on both hands on the rail in a group. Competitors can pass each other without coming too close.

Good pleasure horses have a brisk, animated stride that allows them to comfortably move forward with grace and elegance. Their **correct gaits** result from a balanced, cadenced motion, that emanates from impulsion created by the hindquarters.

**Their natural conformation allows them to carry the head and neck in a natural position.**

Pleasure horses should be calm, willingly, confident and responsive and perform all the gaits straight and correctly. They should be balanced in all aspects and give the appearance they enjoy their job. They should be **a pleasure to ride and pleasing to the eye**. It is the judge's task to find the horse in a competition coming closest to the ideal of the specific class.

*From the ECAHO Green Book:*

**“Judging is not absolute. It requires observation and evaluation. Good judging depends upon correct observance of the points and the selection of the best pleasure horses in that class”.**

Judging is based on certain criteria and rules. However, in judging performance everything is relative. Each horse must be judged against the performance of the others in the class. All faults should be considered according to their severity and the depth of the competition. Good judging depends upon correct observation and the selection of the best horses for the purpose of the class. The best horse, performing the most correctly should be the winner.”

Clear difference in the way of showing the horse in different Pleasure classes is needed.

Hunter Pleasure, Classic Pleasure, Western Pleasure, Traditional Arabian Riding, Ladies Side Saddle.

Incorrectness in the gaits, such as four beat lope or gallop or incorrect jog, must be penalized and judged as major fault.

Neck carriage too low or too high up and against the leads must be penalized.

## Description of main gaits

### WALK – 4-beat gait

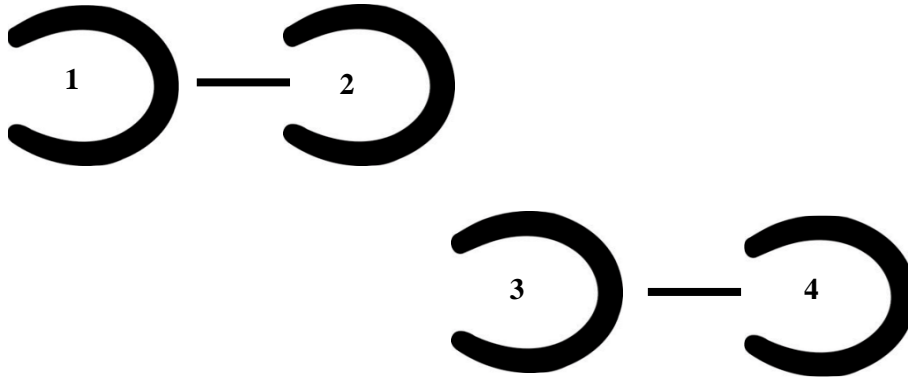

Sequence of footfalls in walk: 1 - left hind, 2 - left fore, 3 - right hind, 4 - right fore

### The Walk

1. **The walk is a marching gait in a regular and well-marked four time beat with equal intervals between each beat. This regularity combined with full relaxation must be maintained throughout all walk movements.**
2. When the foreleg and the hind leg on the same side swing forward almost synchronously, the walk has a lateral rhythm. This irregularity is a serious deterioration of the gait.
3. The following walk are recognized: Medium walk, Collected walk, Extended walk and Free walk. In Pleasure we want to see a Normal or medium walk..
  - a. *Medium walk:* A clear , regular and unconstrained walk of moderate lengthening. The horse, remaining “on the bit”, walks energetically but relaxed with even and determined steps, the hind feet touching the ground in front of the hoof prints of the fore feet. The rider maintains a light, soft and steady contact with the mouth, allowing the natural movement of the head and neck.

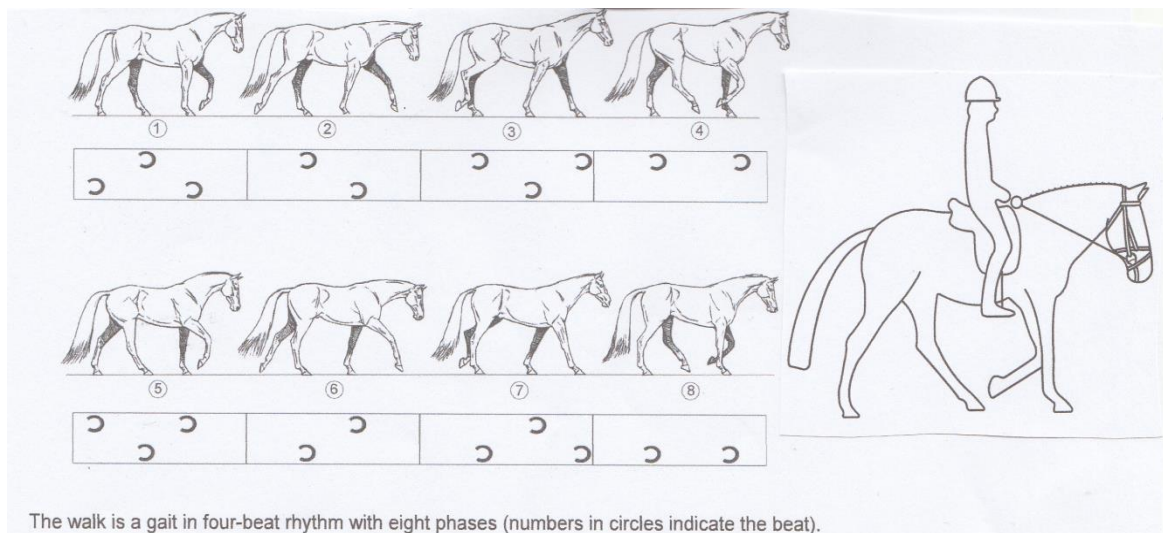



**TROT /JOG – 2-beat gait**

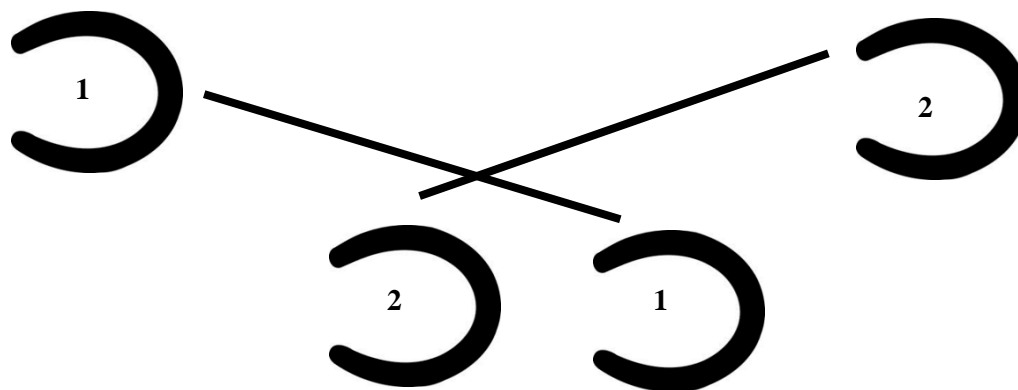

**Sequence of footfalls in jog/trot:** 1 – left hind and right fore, 2 – right hind and left fore

## The Trot/ Jog

1. The trot is two-beat gait of alternate diagonal legs (left fore and right hind leg and vice versa) separated by moment of suspension.
2. The trot should show free, active and regular steps.
3. The quality of the trot is judged by general impression, i.e. the regularity and elasticity of the steps, the cadence and impulsion in both collection and extension. This quality originates from a supple back and well-engaged hindquarters, and by the ability to maintain the same rhythm and natural balance with all variation of the trot.
4. The following trots are recognized: **Normal Trot, Extended Trot.**
  - a. *Normal Trot.* There is a pace between the collected and the medium trot, in which a horse's training is not yet developed enough and ready for collected movements. The horse shows proper balance and, remaining "on the bit", goes forward with even, elastic steps and good hock action. The expression "good hock action" underlines the importance of an impulsion origination from the activity of the hindquarters.
  - b. *Extended Trot.* The horse covers as much ground as possible. Without hurrying, the steps are lengthened to the utmost as a result of a great impulsion from the hindquarters. The rider allows the horse to lengthen the frame and to gain ground whilst controlling the poll. The fore feet should touch the ground on the spot toward which they are pointing. The movement of the fore and hind legs should reach equally forward in the moment of extension. The whole movement should be well-balanced and the transition to collected trot should be smoothly executed by taking more weight on the hindquarter.
5. All trot work is executed "sitting", unless otherwise indicated in the test.

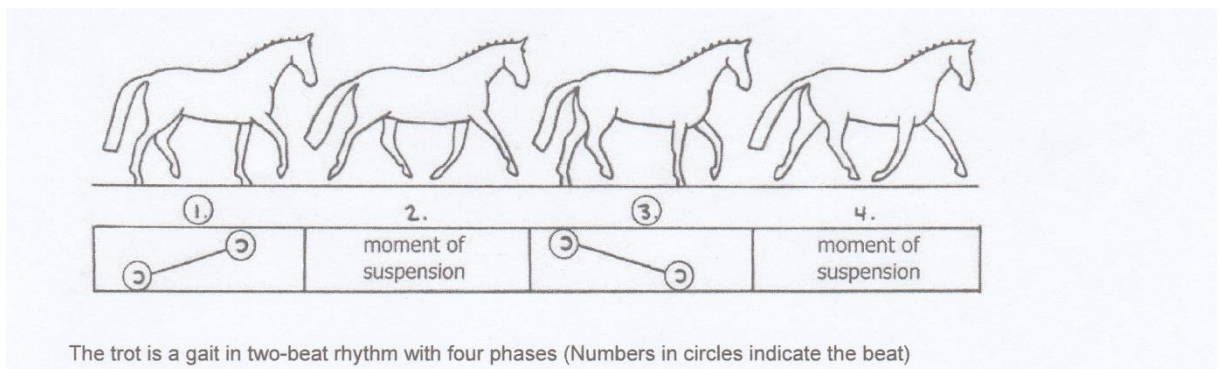

## LOPE / CANTER – 3-beat gait

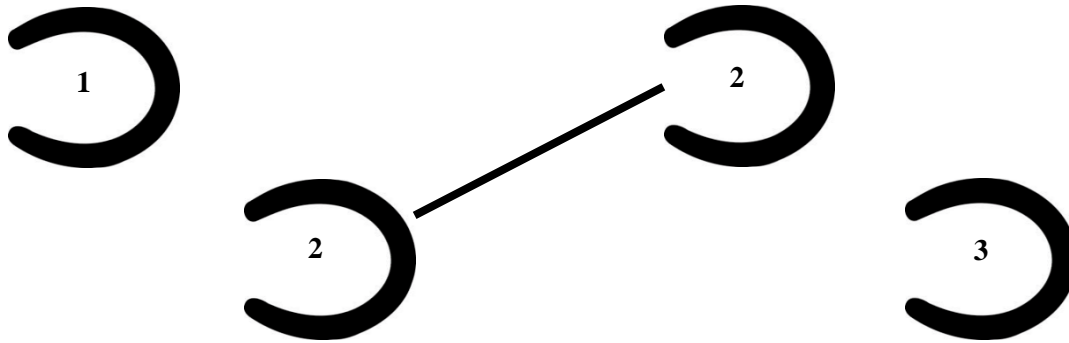

### Sequence of footfalls in lope/canter:

Right lead: 1 – left hind, 2 – right hind and left fore, 3 right fore

Left lead: 1 – right hind, 2 – left hind and right fore, 3 left fore

## The Canter / Lope

1. The canter is a three-beat gait where, in canter to the right, for example, the footfall is as follows: left hind, left diagonal (simultaneously left fore and right hind), right fore, followed by a moment of suspension with all four feet on the air before the next stride begins.
2. The canter, always with light, cadenced and regular strides, should be moved without hesitation.
3. The quality of the canter is judged by the general impression, i.e. regularity and lightness of the steps and the uphill tendency and cadence originating from the acceptance of the bridle with a supple poll and in the engagement of the hindquarters with an active hock action and by the ability of maintaining the same rhythm and a natural balance, even after a transition from one canter to another. The horse should always remain straight on straight lines and correctly bent on curved lines.
4. The following canters are recognized: Working canter, lengthening of strides, Collected canter, Medium canter and Extended canter.
  - a. **Working canter / Lope.** This is a pace the horse shows natural balance while remaining “on the bit”, and goes forward with even, light and active strides and good hock action. The expression “good hock action” underlines the importance of an impulsion originating from the activity of the hindquarters.
  - b. **Extended canter/Hand Gallop.** The horse covers as much ground as possible. Without hurrying, the strides are lengthened to the utmost. The horse remains calm, light and straight as a result of great impulsion from the hindquarters. The rider allows the horse to lengthen the frame with a controlled poll and to gain ground. The whole movement should be well-balanced and the transition to working canter /lope should be smoothly executed by taking more weight on the hindquarters.

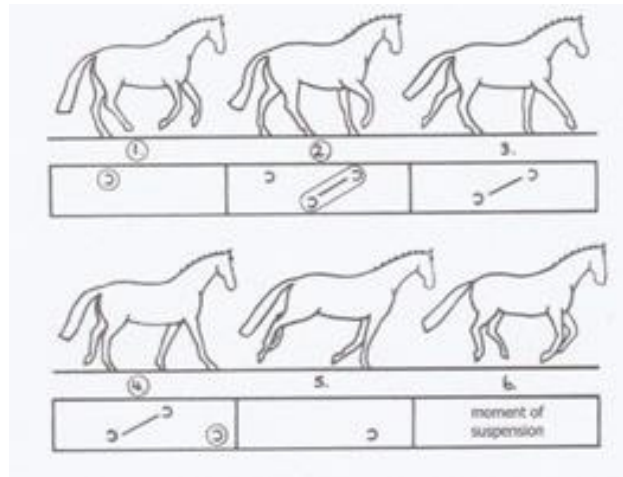

**The canter is a gait in three-beat rhythm with 6 phases.**

## The Rein Back

1. Rein back is a rearward **diagonal movement** with a **two-beat rhythm** but without a moment of suspension. Each diagonal pair of legs is raised and returned to the ground alternately, with the forelegs aligned on the same track as the hindlegs. A four-beat rein back that is not clearly two-beat and diagonal, if done without resistance, could also be scored marginal or better.
2. During the entire exercise, the horse should remain “on the bit”, maintaining its desire to move forward.
3. Anticipation or precipitation of the movement, resistance to or evasion of the contact, deviation of the hindquarters from the straight line, spreading of inactive hind legs and dragging forefeet are serious faults.
4. The steps are counted as each foreleg moves back. After completing the required number of steps backwards, the horse should show a square halt or move forward in the required gait immediately. In tests where a rein back of one horse’s length is required, it should be executed with three of four steps.

## The transitions

1. The changes of gait and pace should be clearly shown at the prescribed marker, they should be quickly made yet must be smooth and not abrupt. The rhythm of a gait or pace should be maintained up to the moment when the gait or pace is changed or the horse halts. The horse should remain light in hand, calm and maintain a correct position.

## The Halt

2. The halt is obtained by the displacement of the horse's weight to the hindquarters by a properly increased action of the seat and legs of the rider, driving the horse towards a softly closed hand, causing an almost instantaneous but not abrupt halt at a previously fixed place.
3. The quality of the gaits before and after the halt is an integral part of the assessment.

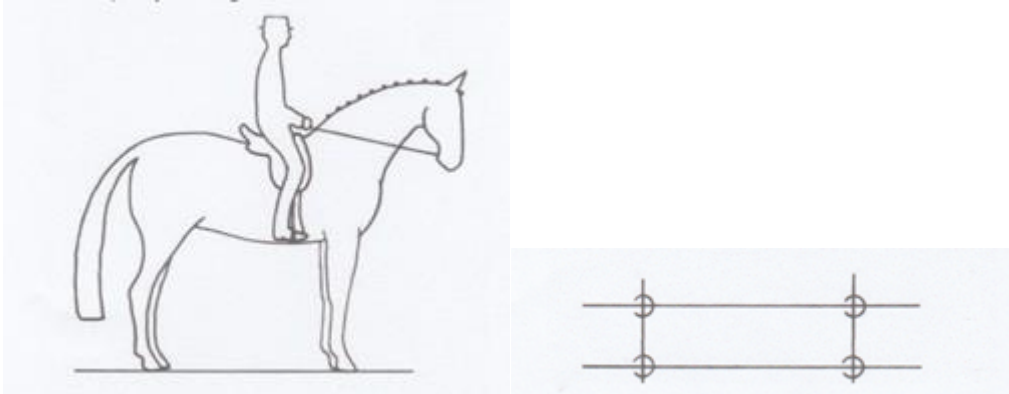

| <b>Gaits</b>         | <b>Good</b>  | <b>Minor faults</b>  | <b>Major faults</b>  | <b>Elimination</b> |
|----------------------|--|--|--|--------------------|
| <b>Walk</b>          | 4-beat gait, ground-covering, flat-footed, balanced, straight, regular, confident, relaxed   | slow, irregular speed, too fast, disinterested, not attentive                        | nervous, jogging, not walking, pulling   |                    |
| <b>Jog</b>           | 2-beat-diagonal-gait, balanced, good motion, consistent, collected, steady, straight, smooth   | too slow/fast  | not performing a 2-beat jog, hard/rough riding, break of gait, poll too high/low   |                    |
| <b>Trot</b>          | 2-beat-diagonal-gait, medium speed with moderate collection, balanced, good motion, straight, consistent, steady, smooth, strength from hindquarters, show lift/elevation of horse's front | too slow/fast  | not performing a 2-beat jog, hard/rough riding, break of gait, pulling, poll too high/low  |                    |
| <b>Extended Jog</b>  | easy riding, balanced, consistent, good motion straight, effortlessly lengthening of strides   | inconsistent speed, loss of cadence or balance or rhythm, looks forced or artificial | break of gait, pulling, hard/rough riding, no increase of speed, no lengthening of strides   |                    |
| <b>Extended Trot</b> | balanced, consistent, good motion, straight, effortlessly lengthening of strides, powerful, reaching   | inconsistent speed, loss of cadence or balance or rhythm, looks forced or artificial | break of gait, pulling, hard/rough riding, no increase of speed, no lengthening of strides, too much/high knee action, unnatural head carriage |                    |

|                                     |   |   |   |   |
|-------------------------------------|---|---|---|---|
| <b>Lope/Canter</b>                  | 3-beat-gait, balanced, good motion, consistent, steady, smooth, easy riding, straight, correct left/right lead, natural head carriage, natural length of strides  | too slow/fast, not straight   | wrong lead, break of gait, pulling, not performing a 3-beat lope, hard/rough riding, poll too high/low                                |   |
| <b>Extended Gallop/ Hand Gallop</b> | 3-beat-gait, see Lope/Canter, further engagement of hindquarters, lengthening of strides without losing frame or cadence, strong, but controlled and balanced, elegant in motion, easily be able to come to a smooth stop at any time | too slow/fast, not straight   | wrong lead, break of gait, pulling, not performing a 3-beat lope, hard/rough riding, poll too high/low                                |   |
| <b>Back</b>                         | 2-beat-gait, proper flexion, responsive, straight, no hesitation  | hesitant, not straight  | throwing head, gaping, pulling not backing, heavy in shoulder   |   |
| <b>General</b>                      | smooth, steady, straight, easy to ride, balanced, regular, unhurried, good attitude/manner, smooth transitions  | over/under flexing, sour ears, tail switching, inconsistent speed, out of balance | throwing head, gaping, break of gaits, schooling, disobedience (kicking, bucking, rearing, biting), improper gaits, poll too high/low | two hands on reins, fingers between closed reins, more than one finger between split reins, changing of hand/reins, double bridle & snaffle reins in one hand, illegal equipment, additional manoeuvres, pulling, fall of horse/rider, blood, lameness, touching the horse/saddle |

## COMMON in all PLEASURE CLASSES

- Pleasure classes are rail classes shown as a group competition.
- Novice/Advanced/Master classes possible.
- The judge calls via ringmaster for the gaits.
- Correct gaits are the most important; four beat lope will be penalized as major fault if ongoing during the whole class even as break of gait.
- Horse must be shown straight.
- Nose of the horse not behind vertical and head set not under the withers.
- For clear identification it is necessary to wear the entry number on both sides on the blanket in visible size!
- Competitors enter the ring in counter clockwise direction or follow the advices of the judges.
- The mane and tail of the Arabian horse shall remain unbraided. Clipped bridle pad allowed. Braided mane & tail only allowed: Dressage (braided mane) and Hunter Pleasure (braided tail).
- No posting allowed except in Hunter pleasure!
- Spurs are allowed according to the specific rules.
- Light rein contact can be maintained at all gaits.
- Passing other competitors is allowed on the 2<sup>nd</sup>/3<sup>rd</sup> track without disturbing the others
- Reverse at the walk/jog/trot possible as to be called for by the judge
- Always to be reversed to the inside of the arena away from the rail
- **Not allowed:** circles, stops, diagonals = additional manoeuvres lead to disqualification.
- Other equipment than allowed or used in incorrect way, leads to disqualification.
- Judges are allowed to check on the equipment!
- Logos, etc. according to ECAHO BB rules not allowed.
- No martingales, tiedowns, bandages or boots.
- No numbers, wrong numbers, or only one number will be penalized with disqualification.

In all Classic classes, riders should wear dressage style coats of traditional colours such as navy, dark green, grey, black, or brown. Maroon and red are improper. Breeches are to be of traditional shades of buff, khaki, canary, light grey or rust (or jodhpurs), with high English boots of black or brown colour. Black, navy blue or brown hard hat, and helmet for youth is mandatory. A tie or choker is required. Gloves, spurs of the unrowelled type that are blunt, round or that include a smooth rolling ball and no longer than one inch. For special requirements for whips please see the conditions for classes. Hair must be neat and contained (as in net or braid). Judges must penalize contestants who do not conform.



## CLASSIC PLEASURE



Classic Pleasure can trace its roots to the bygone era when horses represented the primary mode of transportation to and from town. Society members prided themselves with showing off their elegant and finally-trained saddle mounts as they rode through the parks and into town, dressed in their finest hacking attire. These horses exemplified smooth-gaited movement, impeccable manners and superior tractability, making them a true pleasure to ride. In today's showing Classic Pleasure horses must exhibit impeccable manners, obedience and suitability as a pleasure riding or driving horse.

Transitions from one gait to the other should be smooth, prompt and effortless. Emphasis is placed on a true flat walk with special consideration being given to those entries that represent a true recreational type, general riding mount or driving horse. Entries should not exhibit extreme motions, speed or resistance of any type. Horse must stand quietly and back readily in the line-up.

### Rider's & horse's equipment

- Equipment for dressage classes according to FEI
- Equipment should fit the class (novice, advanced, masters)
- No posting!
- Spurs optional
- Whips or crops allowed, but max. length 80 cm! Used in a way that do not irritated the other competitors
- Caverson with no tight adjustments, no breathtaking ways for using

### Qualifying Gaits

The horse should give the impression of being a pleasure to ride and show a mannerly attitude. All gaits must be performed straight and willingly with ease, cadence and balance. Transitions should be smooth. Horse should be shown on a light contact at the leads, nose not behind the vertical line, correct neck set as usual in Dressage.

- Competitors enter the ring in **counter clockwise** direction in **Normal Trot**
- **Walk:** a four-beat gait, brisk, flat-footed with good reach
- **Normal Trot:** a two-beat gait, performed at medium speed with moderate collection, mannerly, cadenced, balanced and free-moving.
- **Extended Trot:** a bit faster and stronger than normal trot but with a visible difference to it; performed with a lengthened stride, powerful and reaching; in harmony with its own natural stride; show moderate collection without too much action in the front legs
- **Canter:** a three-beat gait, smooth, correct, straight with moderate collection on both hands, not hurried

- **Hand Gallop:** visible difference to canter; performed with a lengthened stride, powerful and ground covering but under control at any time; correct and straight on both hands; in harmony with its own natural stride; extreme speed will be penalized
- **Back:** straight and fluent, without any resistance, to be performed on the center line

### **Judging**

- Judging starts at the moment the competitor enters the arena.
- All gaits are judged equally.
- The rider itself will not be judged but, of course, influences the performance of the horse.
- Disqualifications according to FEI: fall off the horse, riding additional manoeuvres, wrong/not allowed equipment, blood, lameness.
- Penalized if wrong gaits are shown, kicking, bucking, biting, rearing, bolting, pulling, disturbing other competitors.
- Judges can ask for enter on the middle line

## TRADITIONAL ARABIAN RIDING CLASS



(Mounted Native Costumes)

### Equipment

Safety is of utmost importance in tack and attire!

### Rider's equipment

- Native Bedouin type costume including a flowing cape or coat, pantaloons, head dress, scarf or sash, no belly dancer costume
- No whips or crops allowed!
- No objects may be carried other than reins (no weapons, no animals)

### Horse's equipment

- Bits, bridles and saddles: either classic or western, decorated
- All bridles may be used with two hands except western bits.
- A change of reins one handed during the competition is not allowed.
- Blanket has to cover the croup
- Breast collar mandatory

### Qualifying Gaits

The horse should give the impression of being a pleasure to ride and show a mannerly attitude. All gaits must be performed straight and willingly with ease, cadence and balance. Transitions should be smooth.

- Competitors enter the ring in **counter clockwise** direction at the **Canter**
- a ground-covering **Walk**, a correct, straight and smooth **Canter/Lope** and **Hand Gallop** are required
- **No Jog/Trot** demanded
- **No Backing** demanded!
- Line-up head-to tail in two lines (left and right of the centre line) leaving gaps for judging the attire
- Quiet standstill is a must!

### Judging

- Judging starts at the moment the competitor enters the arena.
- All gaits are judged equally.
- 75 % on manners, performance, suitability, quality and conformation
- 25 % on equipment
- The rider itself will not be judged but, of course, influences the performance of the horse.
- Disqualifications according to FEI: fall off the horse, riding additional manoeuvres, wrong/not allowed equipment, blood, lameness
- Penalized if wrong gaits shown, kicking, bucking, biting, rearing, bolting, pulling, disturbing other competitors
- Most important is the correctness of the gaits, especially the lope & hand gallop. Only three beats and lengthen the strides is the most important. Controlled speed is required.

## LADIES SIDE SADDLE



### General

- Western and Classic divided or together in one class (depending on the number of entries) Class in class judging, one ranking, minimum three competitors each style, than two classes & separate ranking.
- Safety is of utmost importance in tack and attire!
- No saddles with rails

### Rider's equipment

- either Classic or Western style
- Spurs, whips or crops optional
- Incomplete clothing might be penalized.
- Lengths of skirt: should as minimum cover the stirrup

- Blouse, jacket, long sleeves

**Classic:**

- English side saddle (period) attire, hat or dark top hat with net, boots, gloves, hair net, no apron

**Western:**

- a long-sleeved blouse/shirt, a western or divided skirt, no apron, hat, western boots

**Horse's equipment**

- Bits must be used according to the rules.
- A change of reins during the competition is not allowed.

**Classic:**

- Dressage bridle, Caverson with no tight adjustments, no breathtaking ways for using
- saddle including balance girth & two horns
- Classic Pleasure gaits are to be shown

**Western:**

- Pleasure bridle, saddle including back cinch & two horns
- Western Pleasure gaits are to be shown, no four beats in lope, correct jog, no neck carriage under the withers, nose not behind the vertical

## Qualifying Gaits

The horse should give the impression of being a pleasure to ride and show a mannerly attitude. All gaits must be performed straight and willingly with ease, cadence and balance. Transitions should be smooth. The Ladies Side Saddle horse let the rider look like a lady. Handsome and willingly follows the rider.

- Competitors enter the ring in **counter clockwise** direction at the **Trot (classic)** or **Jog (western)**
- a ground-covering **Walk**, a comfortable **Jog/Trot** and a flowing, smooth **Lope/Canter** are required
- **No Strong Trot and Hand Gallop required,**
- **European Championships on the discretion of the judges can be asked for extension.**
- **Back:** straight and fluent, without any resistance, to be performed on the centre line
- Quiet standstill is a must!

## Judging

- Judging starts at the moment the competitor enters the arena.
- All gaits are judged equally.
- 85 % on manners, performance, suitability as a side saddle mount, quality and conformation
- **15 % on equipment**
- The rider itself will not be judged but, of course, influences the performance of the horse.
- Disqualifications according to FEI: fall off the horse, riding additional manoeuvres, wrong/not allowed equipment, blood, lameness
- Penalized if wrong gaits shown, kicking, bucking, biting, rearing, bolting, pulling, disturbing other competitors

## HUNTER PLEASURE



### Rider's & horse's equipment

- Equipment no boots, bandages, no red jacket
- Horses are shown under saddle, no jumps
- Posting & sitting in trot on the correct lead and two-position seat (hunter seat) in lope have to be shown
- Direct contact (straight line from the rider's hand to the horse's mouth) but light contact with the horse's mouth must be maintained at all gaits
- Equipment should fit the class (novice, advanced, masters)
- Bridles/browband/Caverson must be of hunter type (no ornamentations)
- No dressage saddles! Military saddles accepted
- Spurs, jumping whips or crops, breastplate or breast collar optional
- Braided mane and/or tail is allowed but not required
- No martingales or tie-downs
- **Informal attire required:** conservative colour, made of materials suitable for hunting, discrete patterns (tweeds, jacquard); Coats must be darker than breeches or jodhpurs
- Gloves optional (conservative colour); Boots and hunting cap or protective headgear are mandatory

### Qualifying Gaits

The horse should give the impression of being a pleasure to ride and show a mannerly attitude. It should be shown more rectangular frame with the neck carried lower and in a relaxed manner. Should give the impression that it is ready to take a jump in the next minute. All gaits must be performed straight and willingly with ease, cadence and balance. Transitions should be smooth. They should stand quietly

- Competitors enter the ring in **counter clockwise** direction in **Normal Trot**
- **Walk:** a four-beat gait, straight, brisk, regular, flat-footed with good reach
- **Normal Trot:** a two-beat gait, straight, regular, performed at medium speed with moderate collection, mannerly, cadenced, balanced and free-moving; exaggerated action must be penalized. Posting or sitting upon request of the judges.
- **Canter:** a three-beat gait, smooth, correct, straight with moderate collection on both hands, not hurried



- **Hand Gallop:** visible difference to canter; performed with a lengthened stride, powerful and ground covering but under control at any time; correct and straight on both hands; in harmony with its own natural stride; extreme speed will be penalized
- **Back:** straight and fluent, without any resistance, to be performed on the center line

### **Judging**

- Judging starts at the moment the competitor enters the arena.
- All gaits are judged equally.
- The rider itself will not be judged but, of course, influences the performance of the horse.
- Correct hunter frame and movement must be credited
- **High headed horses and horses behind the vertical must be penalized**
- Disqualifications according to FEI: fall off the horse, riding additional manoeuvres, wrong/not allowed equipment, blood, lameness
- Penalized if wrong gaits are shown, kicking, bucking, biting, rearing, bolting, pulling, disturbing other competitors

## WESTERN PLEASURE



### Rider's equipment

- Western style according to the rules

### Horse's equipment

- Snaffles/Bits, Bosals, must be used according to the rules
- A change of reins(one hand) during the competition is not allowed, disqualification
- Pleasure bridle/saddle and attire

**Romal reins** means an extension of braided or round material attached to closed reins. This extension shall be carried in the free hand with a 16-inch (40 cm) spacing between the reining hand and the free hand holding the romal. When using romal reins, the rider's hand shall be around the reins with the wrists kept straight and relaxed, the thumb on top and the fingers closed lightly around the reins. When using a romal, no fingers between the reins are allowed.

- At the end of the competition each judge expresses his/her judgement through a placing and signs it. After the judges have finished their individual placings, their placings will be considered as points, added up and reordered to a new placing that will show the final result. The competitor with the lowest points wins the competition. Both individual placings and the final result will be made official through the show office
- Bosal with hair rope / Mecate for horses 6 + in one hand possible

### Qualifying Gaits

The horse should give the impression of being a pleasure to ride and show a mannerly attitude. All gaits must be performed straight and willingly with ease, cadence and balance. Transitions should be smooth. All gaits should be shown correct.

- Competitors enter the ring in **counter clockwise** direction at the **Walk**
- a natural, flat-footed **Walk**, a comfortable, smooth **Jog** and a flowing, smooth **Lope** are required
- **Extended Jog and Canter** may be asked in advanced/master classes
- **Back**: straight and fluent, without any resistance, to be performed on the centre line
- Quiet standstill is a must!

### Judging

- Judging starts at the moment the competitor enters the arena.
- All correct gaits are judged equally.
- The horses are judged on manners, performance, suitability as a pleasure horse, quality and conformation. Natural head & neck carriage.
- Poll of the head under the withers of the horse has to be penalized
- Walk has to be ground covering, not digging the ground forwards upwards, with extreme slowness, this has to be penalized
- Lope in four beats is a important fault and has to be penalized.
- The rider itself will not be judged but, of course, influences the performance of the horse.
- Disqualifications according to FEI: fall off the horse, riding additional manoeuvres, wrong/not allowed equipment, blood, lameness
- Penalized if wrong gaits shown, kicking, bucking, biting, rearing, bolting, pulling, disturbing other competitors

| WESTERN PLEASURE CHART | GOOD  | MINOR FAULTS   | MAJOR FAULTS  | ELIMINATION   |
|------------------------|---|--|---|---|
| <b>WALK</b>            | Ground covering<br>Flat Footed<br>Good attitude   | Slow<br>Not Attentive<br>Fast  | Nervous<br>Jigging<br>Not walking<br>Intimidated walk   | Two hands on reins<br>(except when using snaffle/hackamore)<br><br>Unnatural tail carriage                                      |
| <b>JOG</b>             | Good movement<br>Consistent<br>Steady   | Too slow<br>Too fast<br>Inconsistent rate & carriage   | Not performing a two-beat jog<br>Failing to jog both front and back<br>Hard or rough riding<br>Wogging<br>Short stepping  | Fingers between closed reins or more than one finger between split reins  |
| <b>LOPE</b>            | Good movement<br>Consistent<br>Steady   | Too slow<br>Too fast<br>Inconsistent rate & carriage   | Not straight<br>Improper leads<br>Luggin/pulling<br>Not performing a three-beat lope  | Kicking   |
| <b>HAND GALLOP</b>     | True lengthening of stride & frame  | Too fast<br>Inconsistent rate & carriage   | Extreme speed<br>No distinction in change of frame<br>Obvious loss of control   | Illegal equipment   |
| <b>BACK</b>            | Proper flexion<br>Readily responsive<br>Backs a straight line   | Hesitating<br>Not straight   | Resistant<br>Throwing head<br>Gapping<br>Pulling<br>Refusal<br>Rearing<br>Failure to return to original place   | Lameness  |
| <b>GENERAL</b>         | Uninterrupted gait<br>Proper movement<br>Obedient and soft<br>Smooth<br>Steady<br>Proper flexion<br>Balance<br>Good attitude<br>Self carriage | Over and under flexion<br>Sour ears<br>Switching tail<br>Inconsistent speed<br>Out of balance<br>Poll too high or too low to throw horse<br>out of balance<br>Improper or incomplete appointments<br>Transitions-excessive use of cues | Gaits not straight and true<br>Agitated tail<br>Throwing head<br>Bad mouth<br>Excessive use of bridle<br>Gapping<br>Constant breaking of gaits<br>Obvious schooling<br>Intimidation<br>Undue stress | Cueing horse in front of cinch<br><br>Fall of horse or rider<br><br>Blood<br><br>Horse/rider interference with balance of class |

## PLEASURE DRIVING

### Driver's attire

- No blanket over the driver's knees allowed!
- Hat, gloves and driving whip mandatory
- Header must be properly attired for competition.

### Appointments

- To be shown in light show harness (1-in-hand), bridle with blinkers, over check (with separate over check bit) or side check (separate side check bit optional), and snaffle bit. Equipment to be in sound condition.
- Either a two or four-wheeled vehicle suitable to the horse is required.
- Use of a two-wheeled vehicle is encouraged.
- One header per horse may be utilized to ensure the safety of exhibitors.
- All vehicles approved for Dressage Driving for 1-in-hand are permitted for Pleasure Driving, without groom.



### Qualifying Gaits

The horse should give the impression of being a pleasure to drive and show a mannerly attitude. All gaits must be performed straight and willingly with ease, cadenced and balanced and free-moving. Transitions should be smooth.

- Competitors enter the ring in **counter clockwise** direction at the **Jog**
- Judges may ask for **Walk, Jog, Normal Trot and Strong Trot, Back**
- **Walk**: 4-beat gait, brisk, true and flat-footed with good reach.
- **Jog**: smooth, ground-covering, two-beat diagonal gait. Jog should be square, balanced and with straight forward movement of the feet.
- **Normal trot**: to be performed at medium speed with moderate collection.
- **Strong trot**: faster and stronger than the normal trot, with a lengthened stride, powerful and reaching; in harmony with its own maximum natural stride. The horse must not be strung out behind. It should show moderate collection **without** exaggeratedly high action in front.
- Extreme speed to be penalized.
- To **stand quietly** at the middle line with head to the judges and to **back readily**.
- To be judged on manners, performance and quality.

### Technical Rules for Cart & Buggy

- Length of shafts, 88'', 96'' suitable to the horse.
- Cart to be used only with Boot & Basket.
- Seat to be flat, stitched, slightly formed
- For the Buggy (fine harness buggy) a low rail is permitted.
- Size of the wheels for Carts: wheels with spokes, pneumatic tires: 24''-26''. Wooden wheels 26'' – 30''. Size of the wheels for Buggies: 26'', pneumatic tires only.
  - Wooden shafts only.
  - No back-rest or rails
  - Measurements between the shafts in front of the driver seat (track centre): 49''
  - Any colour permitted; the Cart may be entirely from wood.

**Bits permitted in Pleasure Driving**

The most common bits are:

- Smooth Copper Moth Half Cheek
- Smooth Straight Half Cheek
- Plain Half Cheek
- Smooth 4Ring Bit
- Plain Overcheck Bit

**Bridle & Harness for Pleasure Driving**

- Driving Whip with short lash, maximum 180 cm (6 feet) length of whip to reach the shoulder of the horse. Lash ca. 20 - 30 cm.
- Cart with dash, screen or solid, with rail
- Formal Driving Show Buggy, varnished.
- Cart with pneumatic tires, spoke-wheels, varnished.
- Cart in natural wood and wooden wheels with rubber.

**Judging**

- Judging starts at the moment the competitor enters the arena.
- All gaits are judged equally.
- **Header touching the horse must be penalized!**
- The horses are judged on manners, performance, suitability as a pleasure driving horse, quality and conformation
- The driver itself will not be judged but, of course, influences the performance of the horse.
- Disqualifications according to FEI: fall off the carriage, driving additional manoeuvres, wrong/not allowed equipment, blood, lameness
- Penalized if wrong gaits shown, kicking, bucking, biting, rearing, bolting, pulling, disturbing other competitors

**TRAIL SCORE SHEET** Judge \_\_\_\_\_ Class \_\_\_\_\_ Date \_\_\_\_\_

Obstacle Scores: +1½ Excellent, +1 Very Good, +1/2 Good, 0 Correct, -1/2 Poor, -1 Very Poor, -1½ Extremely Poor

Penalty ½: Each tick of log, pole, cone or obstacle

Penalty 1: Hit or step on; Incorrect gait at walk or jog 2 strides or less; Both feet in space; Skip space; Split pole, failure to meet the correct strides on trot over & lope over log

Penalty 3: Break gait at walk or jog over 2 strides; Out of lead or break of gait at lope; Knockdown; step out or jump off with 1 foot

Penalty 5: Failure to follow the correct line of travel within or between obstacles; Drop object; 1<sup>st</sup> Refusal or evade; 2<sup>nd</sup> refusal; Loss of control at gate, use of either hand; step out or jump off obstacle with more than one foot; Blatant disobedience; Failure to complete obstacle

Penalty Score 0: Use of more than 1 finger between reins; Use of 2 hands; Use of romal other than outlined; Performing obstacles incorrectly or other than in specified order; No attempt to perform obstacle Equipment failure; excessively touching horse; fall to the ground; failure to enter, exit or work obstacle from correct side or direction, including overturns of more than ¼ turn; failure to work an obstacle other than how it's described; outside boundary marker of arena or course area; 3<sup>rd</sup> refusal; failure to demonstrate correct lead or gait; on line of travel, head consistently carried too low or over flexed, except in novice classes

| W/O | Entry No. | Obstacle Description   | 1 | 2 | 3 | 4 | 5 | 6 | 7 | 8 | 9 | 10 | 11 | 12 | Penalty Total | FINAL SCORE |
|-----|-----------|------------------------|---|---|---|---|---|---|---|---|---|----|----|----|---------------|-------------|
|     |           | Penalty Obstacle Score |   |   |   |   |   |   |   |   |   |    |    |    |               |             |
|     |           | Penalty Obstacle Score |   |   |   |   |   |   |   |   |   |    |    |    |               |             |
|     |           | Penalty Obstacle Score |   |   |   |   |   |   |   |   |   |    |    |    |               |             |
|     |           | Penalty Obstacle Score |   |   |   |   |   |   |   |   |   |    |    |    |               |             |
|     |           | Penalty Obstacle Score |   |   |   |   |   |   |   |   |   |    |    |    |               |             |
|     |           | Penalty Obstacle Score |   |   |   |   |   |   |   |   |   |    |    |    |               |             |
|     |           | Penalty Obstacle Score |   |   |   |   |   |   |   |   |   |    |    |    |               |             |
|     |           | Penalty Obstacle Score |   |   |   |   |   |   |   |   |   |    |    |    |               |             |
|     |           | Penalty Obstacle Score |   |   |   |   |   |   |   |   |   |    |    |    |               |             |
|     |           | Penalty Obstacle Score |   |   |   |   |   |   |   |   |   |    |    |    |               |             |

Judges Signature \_\_\_\_\_

## TRAIL Western & Classic & Hand Trail



This class will be judged using the ECAHO, USEF = AHA, AQHA rules

### Western or Classic Trail Appointments

1. For rules regarding correct Western Trail appointments, refer to Western Pleasure - Appointments.  
Advanced & Master levels depending on the age of the horse: up to six years snaffle bit or Bosal can be used, with both hands with correct bridle: Snaffle bit with browband & throat lash.  
To use a bit on a younger horse is upon discretion of the rider. 6 years old and older horse, with western bit or bosal in one hand, hairrope or mecate, no split reins.
2. For rules regarding correct Classic Trail Appointments refer to Classic Pleasure, Hunter Pleasure or Dressage Appointments. No double bridle recommended.

### Levels:

- N minimum of 6 obstacles, easy transitions + simple pattern, no lope over poles  
 A minimum of 8 obstacles, 2 combinations, 4 poles elevated  
 M minimum of 10 obstacles, 3 combination, 6 poles elevated, lead changes flying or simple

In NOVICE (N) horses regardless their age can be ridden with snaffle bit/ bosal and both hands.



Examples of Trail Obstacles:

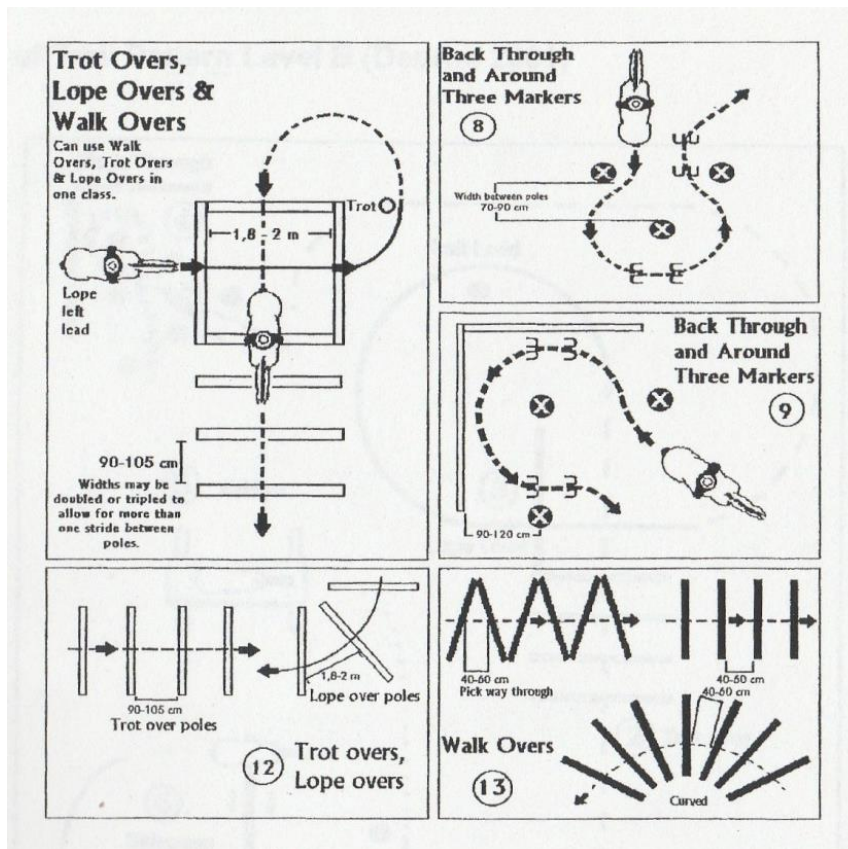
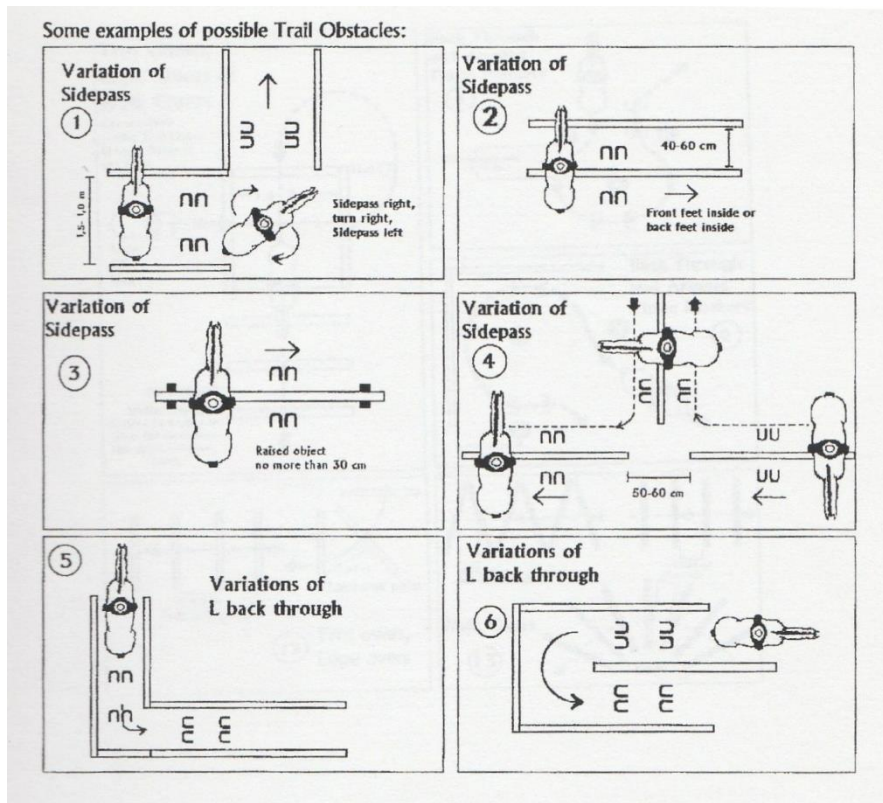

## Working

1. Trail horses are required to work over and through obstacles.
2. No horse may enter the trail course area until the course and the judge are ready.
3. Riders will be permitted to inspect the course on foot during the Judge's instructions prior to the start of the class.
4. Tests which may be required are: negotiating gate, carrying objects from one part of arena to another, riding through water, over logs or simulated brush, riding down into and up out of ditch without lunging or jumping, crossing a bridge, backing through obstacles, side passing, and performing over any reasonable conditions encountered along the trail.
5. Unnatural obstacles, such as fire extinguishers, perforated plywood in water boxes, live animals or unsafe elements such as hay bales, should be avoided.
6. Course to include a minimum of six obstacles.
7. Care in preparing the course should be exercised to prevent a direct advantage to either a small or large horse.
8. Rider's hands shall be clear of horse to avoid cueing.
9. Horses to be penalized for any unnecessary delay while approaching obstacle. Judges are encouraged to advance on to next obstacle any horse taking excessive time at an obstacle.
10. Two or more horses may be entered by the same exhibitor and the same rider may elect to show more than one horse.
11. Obvious unsoundness must be disqualified with no prize awarded.
12. Rail work shall not be required.

## Conduct

### **ECAHO rules & Scoring system must be used.**

1. This class will be judged on the performance of the horse over obstacles, with emphasis on manners, response to the rider, and quality of movement. Credit will be given to horses negotiating the obstacles with style and efficiency, providing correctness is not sacrificed. Horses should receive credit for showing attentiveness to the obstacles and the capability of picking their own way through the course when obstacles warrant it, and willingly responding to the rider's cues on more difficult obstacles.
2. Horses shall be penalized for any unnecessary delay while approaching or negotiating the obstacles. Horses with artificial appearance over obstacles should be penalized.
3. Horses must not be required to work on the rail. The course must be designed, however, to require each horse to show the three gaits (walk, jog at least 30 feet, lope right and left lead) somewhere between and or over obstacles as a part of its work, and quality of movement and cadence should be considered as part of the manoeuvre score.
4. The course to be used must be posted at least one hour before scheduled starting time of the class.
5. The judge may alter the course prior to the course walk.
6. If at any time the trail obstacle is found to be unsafe, it shall be repaired or removed from the course. If it cannot be repaired and horses have completed the course, the score for that obstacle shall be deducted. No horse shall be asked to repeat the course, except in the case of a tie.

7. All entered exhibitors will be allowed to walk and inspect the course with the judge and the course designer, if present, prior to the start of the class. Junior exhibitors may be accompanied by their trainer.
8. It is recommended that the course is no longer than 3 minutes per horse, depending on the level.
9. It is recommended to have at least 30 feet between obstacles, when arena is big enough to permit it.
10. It is not recommended for walkovers/bridge/back through combinations.
11. No Time Outs will be allowed.

## Definitions

1. **KNOCKDOWN:** When any component, element, or portion of an obstacle is displaced from its original position by horse and rider.
2. **REFUSAL:** Any action taken by the horse to avoid performing an obstacle, part of a combination of obstacles or portion of a trail course. These actions may include, but are not limited to, the following:
  - a. **Balking:** Any action that results in a horse blatantly and continuously refusing a rider's command.
  - b. Evading or running past an obstacle.
  - c. Each complete loss of the gate.
  - d. Any blatant action by the horse that demonstrates any unwillingness to approach, negotiate and/or complete an obstacle.
  - e. Negotiating an obstacle in a manner that does not constitute elimination but is not in accordance with course directions.
3. **OFF-COURSE:**
  - a. Taking an obstacle in the wrong direction.
  - b. Negotiating an obstacle from the wrong side.
  - c. Skipping an obstacle unless directed by the Judge.
  - d. Negotiating obstacles in the wrong sequence.
  - e. Not following the correct line of travel. (i.e. the drawn pattern and Judge's instructions)

## Scoring Procedures (this scoring system is optional)

1. The prescribed Score Sheet may be used. Obstacle scores and any penalties will be totalled to arrive at a final score.
2. Scores to be announced following the conclusion of each work and before the next horse begins the course.
3. Score Sheets may be posted.
4. For method of breaking ties, refer to the order of the Judges' cards.
5. All horses enter the arena with a score of 70. With each obstacle, the judge will instruct a scribe to assign a score as well as any appropriate penalties if one or more occurs. At the end of the work, obstacle scores will be totalled. Any penalties will then be subtracted to arrive at a final score. All horses are judged from the time they enter the arena until the completion of the last obstacle.
6. Judge(s) may review official video on "No Score", "Zero", and "5 point penalties" only. (Video Review is solely the Judge(s) decision.)
7. In the case of a displaced obstacle not being corrected, the Judge may grant a re-ride.
8. Scoring will be on the basis of 0-infinity, with 70 denoting an average performance. Each obstacle will receive an obstacle score that should be added or subtracted from 70 and is subject to a penalty that should be subtracted. Each obstacle will be scored on the following basis, ranging from plus 1 1/2 to minus 1 1/2:

- -1 1/2 extremely poor
- -1 very poor,
- -1/2 poor
- 0 correct
- +1/2 good
- +1 very good
- + 1 1/2 excellent

Obstacle scores are to be determined and assessed independently of penalty points.

Penalties should be assessed per occurrence as follows.

9. The following deductions will result:

**0-SCORE Disqualification(horse will be in the ranking with 0)**

- Use of more than one finger between the reins
- Use of two hands (exception in Snaffle Bit or Hackamore classes designated for two hands & classic trail) or changing hands on reins; except for junior horses shown with hackamore or snaffle bit, only one hand may be used on the reins, except that it is permissible to change hands to work an obstacle
- Performing the obstacles other than in specified order
- No attempt to perform an obstacle
- Equipment failure that delays completion of pattern
- Touching the horse on the neck to lower the head, or use of free hand to instill fear or praise
- Fall to the ground by horse or rider
- Failure to enter, exit or work obstacle from correct side or direction
- Failure to ride correct line within or between obstacles
- Failure to work an obstacle in any manner other than how it's posted on course  
- Riding outside designated boundary marker of the course
- Third refusal on course
- Cueing horse in front of cinch

**½ POINT**

- For each tick of log, pole, cone or obstacle

**1 POINT**

- Each major hit of or stepping on a log, pole, cone or obstacle –
- Both front or hind feet in a single-stride slot or space –
- Skipping over or failing to step into required space
- Split pole in lope-over (pole between two front or two hind feet at lope)
- Out of lead
- Incorrect or break of gait (including to correct a lead)for two strides or less

**3 POINTS** (depending on severity)

- Stepping outside of the confines of an obstacle with designated boundaries (back thru, side pass, 360° box) with one foot once the horse has entered the obstacle.
- Knocking down an elevated pole, jump, cone, barrel, plant or obstacle, severely disturbing an obstacle,
- Missing or evading pole that is a part of a series of an obstacle with one foot
- Incorrect or brake of gate at walk or jog for more than two strides.
- Out of lead or break of gate at lope( except when correcting an incorrect lead)

- Falling or jumping off or out of a bridge or a water box with one foot once the horse has got onto or into the obstacle

**5 POINT** (any entry with a 5 point penalty as listed below cannot place over another entry that completes the course without a 5 point penalty)

- Dropping slicker or object required to be carried on course
- First or second cumulative refusal, balk, or attempting to evade an obstacle by shying or backing more than 2 strides away - Letting go of gate or dropping rope gate
- Blatant disobedience (kicking out, bucking, rearing, striking)
- Failure to ever demonstrate correct lead or gait, if designated
- Failure to complete obstacle
- Second refusal, balk, or attempting to evade an obstacle by shying or backing more than 2 strides away
- Severely disturbing an obstacle.
- Falling or jumping off or out of an obstacle (bridge or water box).
- Holding saddle with either hand touching horse by hand
- Faults which occur on the line of travel between obstacles, scored according to severity:
  - head carried too high
  - head carried too low (Tip of ear below withers)
  - over-flexing or straining neck in head carriage so the nose is carried behind the vertical
  - excessive nosing out
  - opening mouth excessively

**NO SCORE Elimination (horse will be not ranked)**

- Infraction of any state or federal law which exists pertaining to the exhibition, care and custody of horses within the state or country where a USEF trail class is being held.
- Abuse of an animal in the show arena and/or evidence that an act of abuse has occurred prior to or during the exhibition of a horse in competition;
- Use of illegal equipment, including wire on bits, bosals or curb chains;
- Use of illegal bits, bosals or curb chains;
- Use of tack collars, tie downs or nose bands;
- Use of whips;
- Use of any attachment which alters the movement of or circulation to the tail;
- Disrespect or misconduct by the exhibitor;
- The judge may excuse a horse at any time while in the arena for unsafe conditions or improper exhibition pertaining to both the horse and/or rider. This may include the exhibition of an animal which is clearly not in a fit or sound condition;
- The use of abusive equipment, and/or the use of abusive showing techniques by the rider;
- The exhibition of a horse that has a cut or abrasion showing clear evidence of fresh blood in the mouth, nose, chin, shoulder, barrel, flank or hip area (those areas reasonable to believe the injury may have been caused by the rider or equipment) must be considered abuse regardless of how the injury was caused.
- While each Judge is required to disqualify a horse exhibited in the manners described above, it should be noted that in every case the exhibitor should be given the benefit of any doubt, should any doubt exist.

## Dimensions of Trail Obstacles

All elevated poles must be in a pole holder, e.g. trail blocks, trail risers, standard jump cups or similar type supports. The Judge has the right to alter the course.

### 1. WALK-OVERS

Single Poles: maximum height 16"

Multiples: maximum height 10"

Minimum width between poles: 20" to 24" or multiples thereof, between poles is generally considered good spacing for walkovers, depending upon difficulty desired. No rolling poles.

### 2. CAVALETTI

Jog overs: 3 feet to 3'6" apart or multiples thereof (space is measured between poles)

Lope overs: 6 to 7 feet apart or multiples thereof - 6 feet is preferable for most horses.

### 3. BACK THRUS

On ground: min. 28" between min.

Elevated: 30" between min.

Barrels: 32" between min.

### 4. SIDE PASSES

Single pole: up to 8" high

Slots: never closer than 24" wide (space is measured between poles)

### 5. SERPENTINES (jog arounds)

Pylons 6 feet apart (base to base) minimum. Guardrails, if used, should be 3 feet to either side of the pylons.

Pylons 3 feet apart (base to base) minimum. Guardrails, if used, should be 6 to 8 feet to either side of the pylons. If tall standards are used, dimensions can be looser.

### 6. GATE

Approximately 60" high with latch available at that height

### 7. BRIDGE

(suggested but not mandatory) dimensions:

minimum of 36" wide, minimum of 6' long, no higher than 12"

### 8. ANY OTHER MANEUVERS

Figure horse's wheelbase at five feet front hooves to back hooves.

### 9. UNACCEPTED OBSTACLES

Animals, Hides, PVC pipe, Dismounting, rocking or moving bridges, Water box with floating or moving parts, Flames, dry ice, fire extinguisher, etc., logs or poles elevated in a manner that permits such to roll.

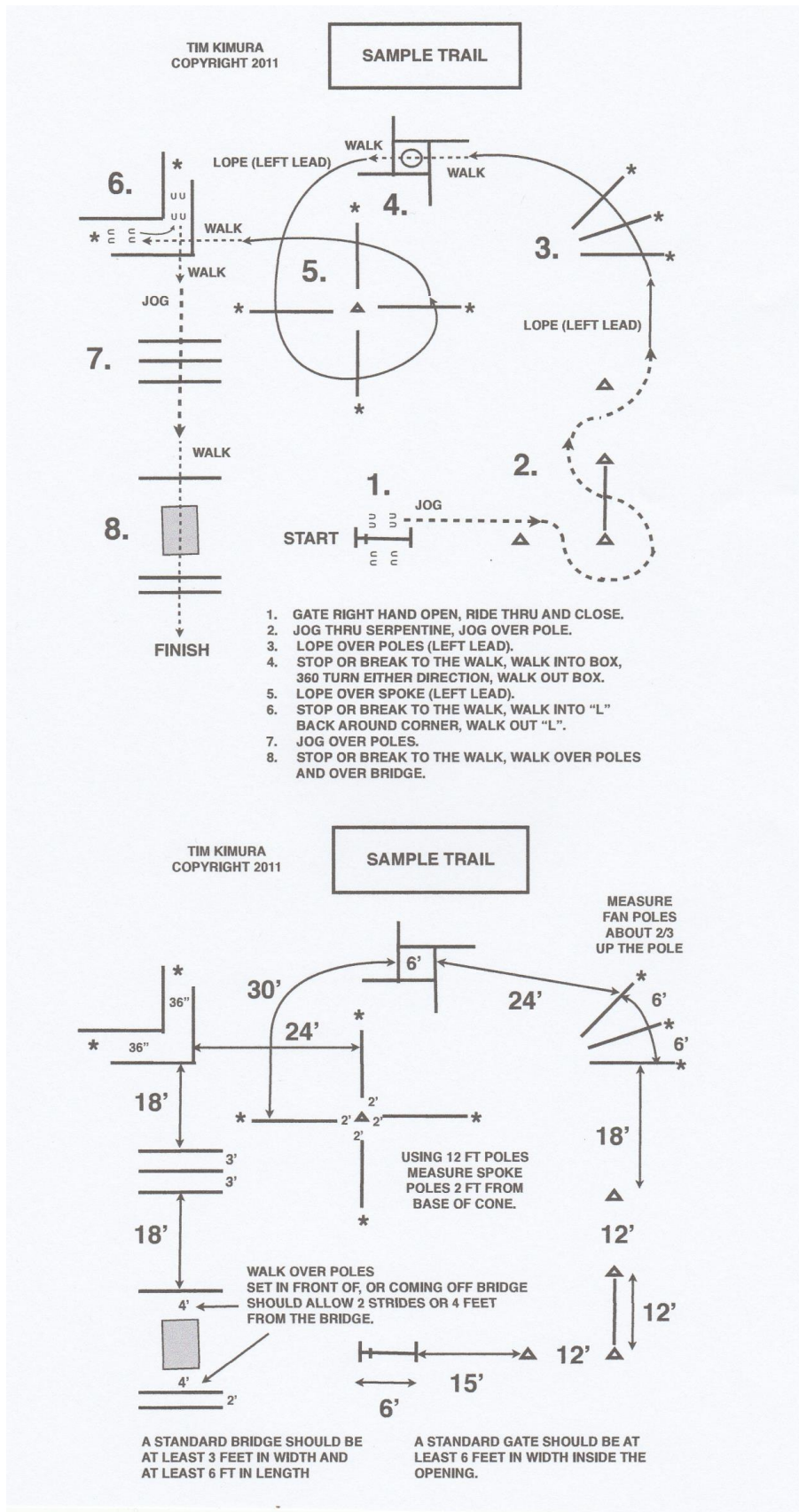

TIM KIMURA  
COPYRIGHT 2011

SAMPLE TRAIL

**WESTERN TRAIL SCORING GUIDELINES**

| TRAIL   | GOOD  | MINOR FAULTS   | MODERATE FAULTS   | MAJOR FAULTS   | NO SCORE/ O SCORE   |
|---|---|--|---|--|---|
| Walk<br>Jog<br>Lope (on the course)   | See Western Pleasure Chart                    |  |   |  |   |
| <b>CONTROL OBSTACLES</b><br><br>Gates<br>Back throughs<br>Side Passes<br>Turns on the forehand or rear<br>Serpentines | Smooth<br>Good position<br>Responsive to aids | Slant side passes<br>Slow response<br>Poor head position   | Stepping outside the confines of back through, side pass, or box<br>Knocking down an elevated pole, jump, cone, barrel, plant, obstacle | Refusals<br>Letting go of gate<br>Failure to complete obstacle<br>Severely disturbing an obstacle  | See WS124.9a and .f for infractions resulting in a "0 score" or "no score."<br><br>Any of these infractions result in no award for the class.<br><br>Three refusals on course |
| <b>AGILITY OBSTACLES</b><br><br>Jumps<br>Walk overs<br>Trot or lope-overs<br>Bridge<br>Tires                          | Attentive<br>Careful<br>Willing               | Major hit of pole, cone or obstacle<br>Front and hind feet in single strided slot<br>Skipping over or failing to step into required space<br>Split pole in lope over<br>Out of lead<br>Poor jumping form<br>Too hesitant | Break of gait   | Refusals<br>Failure to complete obstacle<br>Severely disturbing an obstacle<br>Falling or jumping off of or out of an obstacle (bridge, water box) |   |
| <b>CALMNESS</b><br><br>Water<br>Plastic<br>Brush<br>Plants<br>Carrying objects<br>Dally and drag                      | Steady going<br>Alert<br>Careful but willing  | Tense over obstacles<br>Nervous when carrying objects  |   | Refusals<br>Dropping slicker or object<br>Severely disturbing an obstacle<br>Falling or jumping off of or out of an obstacle (bridge, water box)   |   |



|         |  |  |  |  |  |
|---------|--|--|--|--|--|
| GENERAL |  |  |  | Blatant disobedience (kicking, bucking, rearing, striking)<br>Failure to demonstrate correct lead or gait, if designated |  |
|---------|--|--|--|--|--|

## Handtrail

### General:

In-Hand Trail may combine the Western and Classic style competitors.

Hand Trail will follow the ridden Trail rules in judgement.

Horses & handler competing in Trail in Hand are allowed to participate in Trail Novice classes

Combination Novice & Master is not possible with the same horse/rider/handler.

### Age of Horse

From one year on, horses are allowed to be presented in Hand Trail. (Date of birthday is counting not only the year)

### Age of Handler

following the General rules ECAHO Green Book minimum 8 till 12 years old, with accompanied by adult experienced person, standing outside the ring to assists if necessary.

### In-Hand Tack

Suitable halter (leather preferred) (with or without silver trim), leather lead (with or without a chain) to be used. Rope Halters (Parelli style) are not allowed. If a chain is used with the lead it must not be run through the horse's mouth (recommended length: lead max 1,50 m; chain 0,80 cm; no lunge). Whip in dressage style max length 1,10 m with a short tassel or without is allowed. The whip should be only used to show the horse the commands and is not allowed to touch the horse.

The horse is not allowed to be touched by hand during the whole pattern.

### In-Hand Attire

No crop, chaps, chinks, or spurs allowed.

### Western or Classic Hand Trail Appointments

1. For rules regarding correct Western Trail appointments, refer to Western Pleasure or Western Trail - Appointments.
2. For rules regarding correct Classic Trail Appointments refer to Classic Pleasure, Hunter Pleasure Show Jumping or Dressage Appointments.
3. Dress of Handler: Western, Classic Show outfit or Halter show outfit.
4. Hand Trail is possible in costumes (horse + rider) with or without music, as written in invitation.

### 1. LEVELS:

**Novice:** simple pattern

**Advanced:** some elevated poles, side pass, combinations

**Master:** changing of leading hand at the gate following the requirements of the pattern. Lope over elevated poles combinations.

2. A trail horse is one that can manoeuvre through a course of obstacles with physical skill, expression and a good mental attitude. It should travel through and between obstacles with an inquisitive desire to go forward without compromising its calm, relaxed attitude and way of going. It should approach each obstacle squarely with authority and correct form, with its own style, yet maintaining its willingness to be dictated to completely by the rider/handler with no apparent resistance. Maximum credit should be given to the trail horse that negotiates its way through an entire course efficiently, in a timely manner, without excessive hesitation, with curiosity,

expression, smoothness and style; in a manner that raises the degree of difficulty without sacrificing carefulness, control, and/ or attitude. Ultimately, the trail horse is skilful, eye appealing, confident, and leaves one with the impression of being sure, safe and a pleasure to be handled over a course of obstacles.

3. All entered exhibitors will be allowed to walk and inspect the course with the judge prior to the start of the class. Junior exhibitors may be accompanied by their trainer.
4. The course must be designed to require each horse to show all two (2) gaits (walk, jog/trot at least thirty (30) feet, somewhere between and/or over obstacles as part of its work, and quality of movement and cadence should be considered as part of the obstacle score. Unnecessary delays while approaching, or negotiating an obstacle, shall be penalized

4.1. **Scoring system is following the Trail scoring system.** The horse will be judged not the handler. The judge will score the all over impression of handler & horse, the outfit and the condition of the horse in the total scores.

4.2 **Penalization in the total score:** How the maneuvers are shown: moving side wards, too slow, not straight moving and stopping, missing of willingness at any time, will be penalized in the total score.

4.3 **0 score:** (Disqualified, stay in the ranking)

- a. The horse gets loose.
- b. Leading the horse on the wrong side when enter the arena to start with the pattern.
- c. Fall of handler or horse.
- d. Horse does not stay on the right side of handler, additional or left out manoeuvres.
- e. Handler touches horse by hand or whip.
- f. Trail pattern as drawn is binding, mistakes in the gaits between the obstacles, wrong line between or over obstacles, working obstacles not in correct order
- g. More than 4 steps back.
- h. Turn over more than 90°.

**The obligatory obstacles for every pattern:**

minimum 4 steps back up.

minimum 4 poles to walk or trot over

open & close gate, rope gate not wider than 2 m

5. If at any time the trail obstacle is found to be unsafe, it must be repaired or removed from the course. If it cannot be repaired and horses have completed the course, the score for that obstacle shall be deducted. No horse shall be asked to repeat the course, except in the case of a tie.
6. The course must be posted at least twelve (12) hours before the scheduled starting time for the class. One Day Shows and twenty-four (24) hours at National Championship Shows.
7. There shall be a minimum of six (6) obstacles and a maximum of ten (10) obstacles on any course. (Exception: National Championship classes have no maximum number of obstacles.)
8. The judge may alter the course prior to the course walk. Course designer is recommended.
9. The handler leads his horse on the rear (left) side with his right hand. If necessary, on an obstacle the leading hand can be changed. Judge should give credit to that horse do not need a change of leading hand. Changing of leading hand can be a part of the pattern (gate).

## Illustrations

### WESTERN BITS

The description of a legal, standard western bit includes:

8 1/2" (215 mm) maximum length shank to be measured as indicated in the diagram on the previous page. Shanks may be fixed or loose; concerning mouthpieces, bars must be round, oval or egg shaped, smooth and unwrapped metal of 5/16" to 3/4" (8 mm to 20 mm) in diameter, measured 1" (25 mm) from the cheek. However, wire on the sway bars (above the bars and attaching to the spade) of a traditional spade bit is acceptable. They may be inlaid, but must be smooth or latex wrapped. Nothing may protrude below the mouthpiece (bar), such as extensions or prongs, including upward prongs on solid mouthpieces. The mouthpiece may be two or three pieces. A three-piece, connecting ring of 1 1/4" (32 mm) or less in diameter, or a connecting flat bar of 3/8" to 3/4" (10mm to 20 mm) measured top to bottom with a maximum length of 2" (50 mm), which lies flat in the horse's mouth, is acceptable; the port must be no higher than 3 1/2" (90 mm) maximum, with rollers and covers acceptable. Broken mouthpieces, halfbreeds and spades are standard; donut and flat polo mouthpieces are not acceptable; a curb bit must be used with a curb strap or curb chain properly attached so as to make contact with horse's chin;

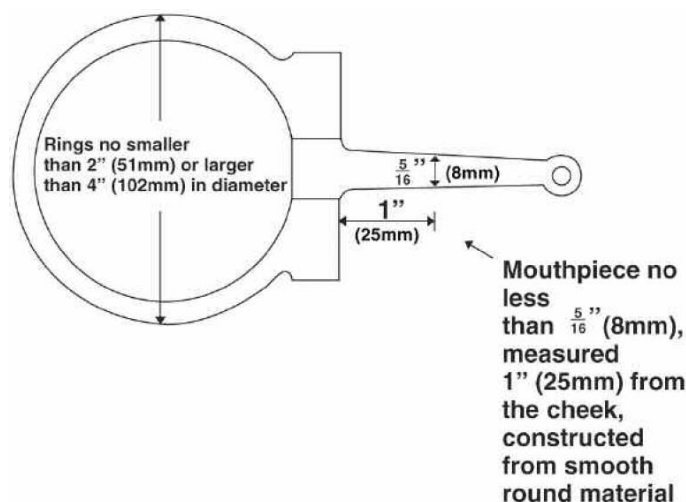
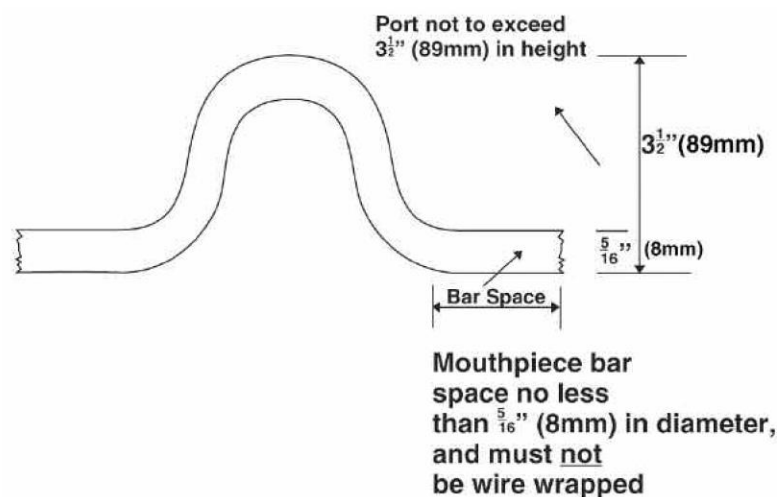

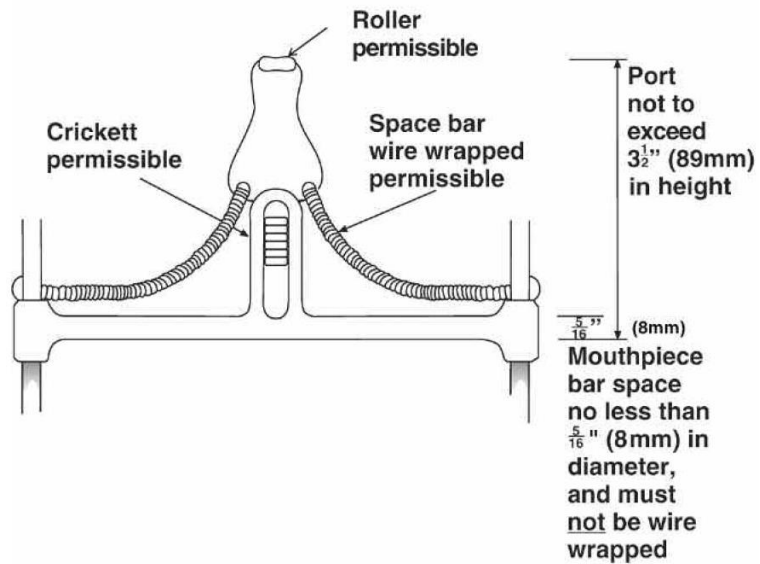
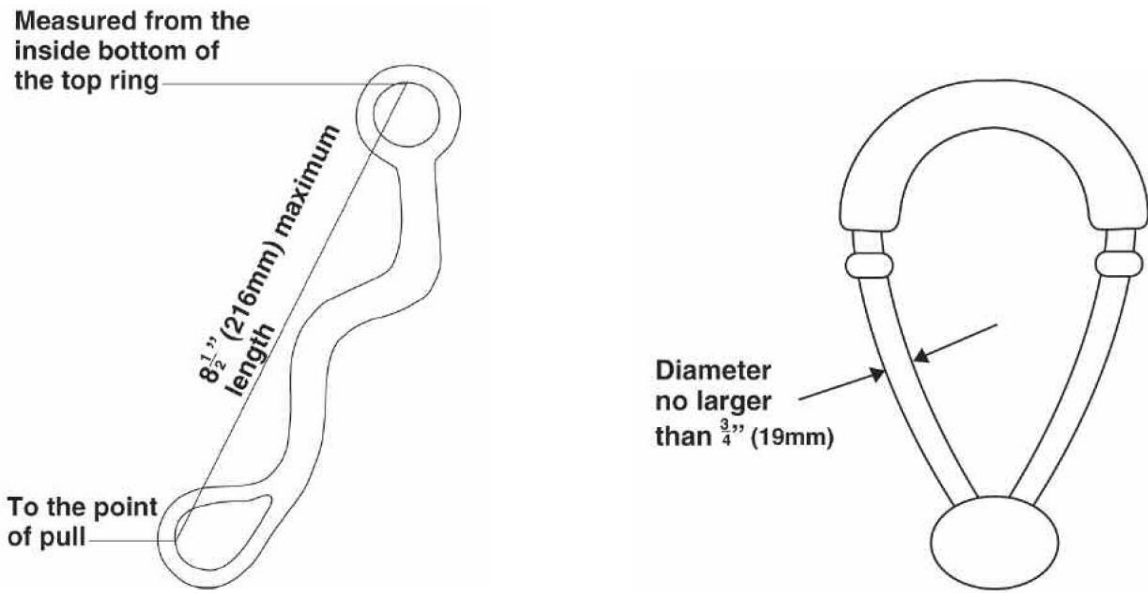

**Illegal bits**

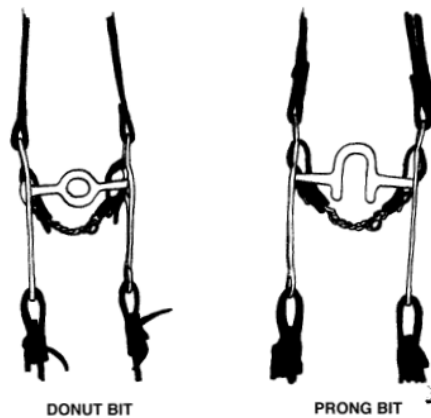

The following photos and drawings server to illustrate the tack rule described in WS105. They are meant to serve as example only. The extensive variety of commercial and custom bits necessitates accurate interpretation of WS105. Please use these photos as guidelines.

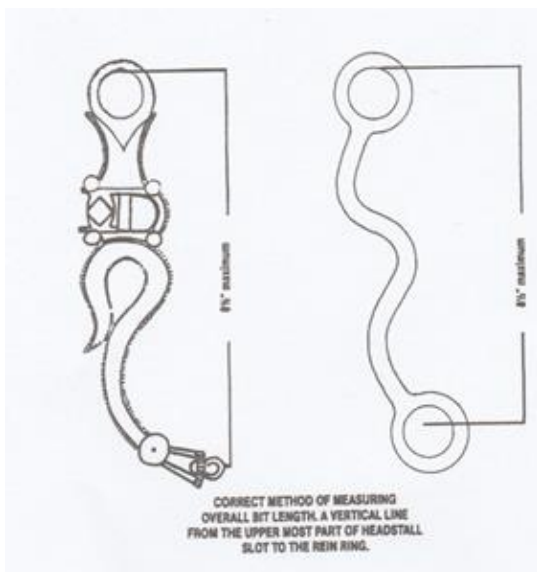

There shall be no discrimination against any standard Western bit. A standard Western bit is defined as having shank with a maximum length overall of 8 1/2”.



The shank on this bit is 9” long – ILLEGAL

*Discussion: The length of the bit shank affects the severity of the bit; the longer the shank the more severe the action of the bit. Standardizing shank*

*length at 8 1/2” or shorter makes for fair competition. When measuring the length, measure from the inside of the uppermost part of the headstall slot to the point on the rein ring where the rein would pull from when pressure is applied to rein.*

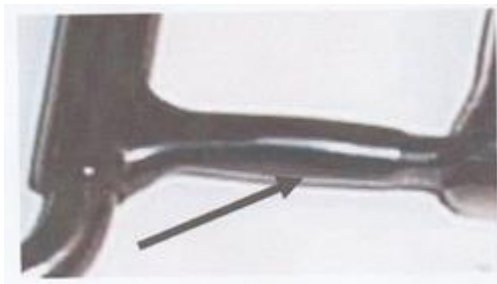

The mouthpiece will consist of a metal bar 5/16” to 3/4” in diameter, as measured 1 inch in from the shank.

*Discussion: A thin mouthpiece is more severe on the bars of the mouth. It would be unusual to see a bit with a mouthpiece of less than 5/16”.*



Bars may be inlaid but must be smooth or latex wrapped.

← This mouthpiece is legal.



Rollers attached to the center of the bit are acceptable, and may extend below the bar.

← This mouthpiece is legal.



Nothing may protrude above or below the mouthpiece (bar) such as extensions, prongs or rivets designed to intimidate the horse.

← This mouthpiece is legal.

*Discussion: The very short, smooth, rounded rivets used to join the mouthpiece together and extend a tiny bit below the bar of the bit will not intimidate the horse.*



*Discussion: Bits with prongs or other protrusions can be very severe and can cause damage to the horse's tongue.*

← This mouthpiece is ILLEGAL.



*Discussion: This bit is often referred to as a Mustache bit. After considerable discussion, it has been deemed illegal. The issue is that the bar of the bit is shaped so that it curves slightly down at the point where the part joins the bar. This creates a slight prong on each side of the port, which can be intimidating to the horse.*

← This mouthpiece is ILLEGAL.



*Discussion: This bit is often referred to as the Mickey Mouse bit. The port of this bit meets all the requirements to be legal. The two balls on the top of the port do not violate the "no prongs" rule. The "no prongs" rule addresses prongs above or below the mouthpiece (bar) designed to intimidate the horse.*

↓ These mouthpieces are legal. ↑



Jointed mouthpieces are acceptable and may consist of two or three pieces and may have one or two joints. A three-piece mouthpiece may include a connecting ring of 1 ¼" or less in diameter or a connecting flat bar of 3/8" to ¾" (measure top to bottom with a maximum length of 2"), which lies flat in the mouth, or a roller or ports as described herein.

↓ All these mouthpieces are legal.



The port must be no higher than 3 1/2" maximum with roller(s) and covers acceptable. Jointed mouthpieces, half breeds and spade bits are standard.

← This mouthpiece is legal.



← This mouthpiece is legal.

*Discussion: Extremely high ports have a very intimidating effect on the horse when the reins are pulled and the port hits the roof of the mouth. Bits with ports this high were used by the Vaqueros in Mexico and California. Several years of training were required for a horse to effectively perform with bits of this type.*



← This mouthpiece is **ILLEGAL**.



Slip or gag bits, rigid donut mouthpieces and flat polo mouthpieces are prohibited.

← This mouthpiece is ILLEGAL.

*Discussion: This bit is used on horses who “gap” or open their mouth when reins are pulled. This is not a traditional Western bit. At various times the bit has been legal. It became illegal again in 1995.*



← This mouthpiece is ILLEGAL.



*Discussion: This is a swivel mouthpiece bit. At various times this bit has been legal and other times illegal. The ports on this bit stays still when the reins are pulled. This bit is effective on horses who “gap”. This bit has allowed some older horse with mouth problems to continue showing.*

↑ This mouthpiece is legal.



*Discussion: This type of bit is used as a training device. It puts pressure on the corners of the mouth. It would be very rare to see anyone try to show a horse with this type of bit.*

← This mouthpiece is ILLEGAL.



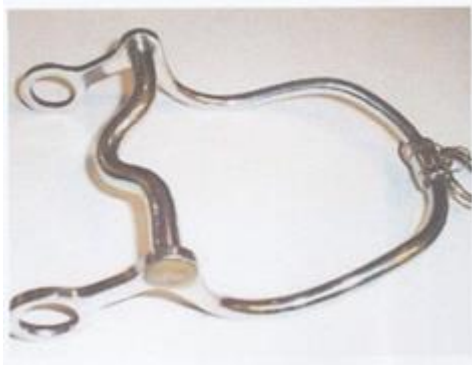

Roping bits with both reins connected to a single ring at centre of cross bar shall not be used. Reins must be attached to each shank.

*Discussion: This bit has no particular advantages in the show ring, it is merely non-traditional western equipment and does not present the proper picture in the show ring. It would most likely be a beginner who simply did not know better that would attempt to show with this bit.*

↑ This mouthpiece is ILLEGAL.



*Discussion: This style of curb is legal for use in the Western division as long as the shank length and mouthpiece meet the rule requirements.*

← This mouthpiece is legal.



Hackamore bits, bosals, cavesson type nosebands, martingales and tie-downs are prohibited.

*Discussion: This is a mechanical apparatus that operates by applying pressure on the nose and jaws. It does not allow the horse to be judged on how well he handles a bit, nor is it traditional western equipment.*



*Discussion: Cavessons, bailing wire, small “pencil” bosals, etc. are used to keep a horse’s mouth closed when the reins are pulled when using a bit. It would be rare that a person would deliberately attempts to enter the competition ring with this type of equipment. It is, however, quite common for the rider to be using this equipment in the schooling area and forget to take it off. If a rider is observed going toward the in-gate using any of these, he should be reminded to remove it.*



← This curb strap is ILLEGAL.



*Discussion: Attachment of curb strap on a snaffle below where reins would be attached is allowed.*

← This curb strap is legal.



A light lip strap is permissible.

*Discussion: The purpose of the lip strap is to keep the shanks of the bit from flipping up above the horse's nose. The light strap (often shoelace) is attached to the end of the bit shanks and to the chinstrap or chain. This should be attached to the chinstrap in such a way that it does not form a knot or significant lump under the horse's chin. The lip strap may go over the top of the chinstrap between the layers of the chinstrap or to be attached to a*

*small metal ring on the bottom of the chinstrap as long as it does not cause a bump which could cause the strap to be too severe.*

**Snaffle bits** in western performance classes mean the conventional O-ring, egg-butt or D-ring with a ring no larger than 4" in diameter (100 mm). The inside circumference of the ring must be free of rein, curb or headstall attachments which would provide leverage. The mouthpiece should be round, oval or egg-shaped, smooth and unwrapped metal. It may be inlaid, but smooth or latex-wrapped. The bars must be a minimum of 5/16" (8 mm) in diameter, measured one inch (25 mm) in from the cheek with a gradual decrease to centre of the snaffle. The mouthpiece may be two or three pieces. A three-piece, connecting ring of 1 1/4" (32 mm) or less in diameter, or a connecting flat bar of 3/8" to 3/4" (10 mm to 20 mm) measured top to bottom, with a maximum length of 2" (50 mm), which lies flat in the horse's mouth, is acceptable. Optional leather strap attached below the reins on a snaffle bit is acceptable.



Chinstrap has a metal bar sewn inside making it stiff under the chin.

← This chinstrap strap is ILLEGAL.



*Discussion: These are more severe than plain leather. The tack strap can cause sores, cuts, and could be considered to be inhumane. If the tacks are sharp, the strap should not be used on competition ground as it is cruel. Use of a magnet will reveal any metal within the chinstrap.*

↑ This chinstrap strap is **ILLEGAL**.



Rounded, rolled, braided or rawhide curb straps are prohibited. Round straps are more severe than flat ones.

← This chinstrap strap is **ILLEGAL**.



← This chinstrap strap is **ILLEGAL**.



Curb chains and leather chin straps may be used but must be flat and at least ½” in width and lie flat against the jaws of the horse.

← Some acceptable curb chains.



*Discussion: The narrower a chain, the more severe it is. A narrow chain has a higher probability of cutting the horse.*

← This curb chain is **ILLEGAL**.



No wire, rawhide, metal or other substance can be used in conjunction with or as part of the leather chin-strap or curb chains.

*Discussion: The bar is narrow and stiff and makes the chain too severe.*

↑ This curb chain is **ILLEGAL**.



*Discussion: The "bumps" cause the chain to be too severe.*

← This curb chain is **ILLEGAL**.

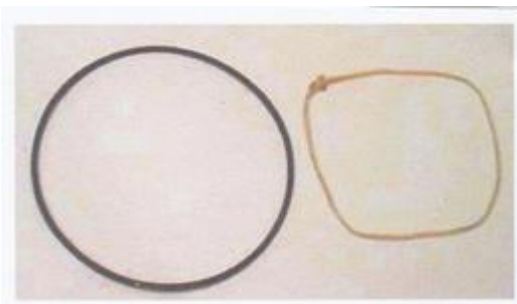

Horses shall not be shown with artificial appliances that would tend to alter their performance.

← These devices are **ILLEGAL**.

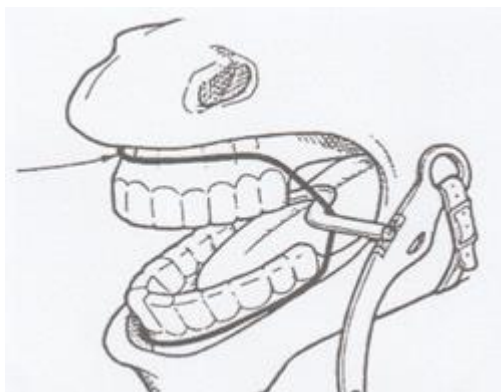

*This drawing illustrates how these devices would typically be placed in the horse's mouth.*

*Discussion: Either of these devices, if used in conjunction with a bit, can put pressure on the gums of the horse causing it to keep its mouth closed and also causing it to respond to a very slight pull on the reins. These devices will usually fall out when the bridle is removed. Care should be taken so that a rider or groom does not "palm" these devices before the steward notices them. Occasionally, the rubber or string will*

*come loose in the ring and be seen hanging out of the horse's mouth. It is not unheard of to have elaborate dental work done so that a wire can be attached to the back teeth and then around the gum.*

Hackamore means the use of a flexible, braided rawhide, leather or rope bosal, the core of which must be flexible. A hackamore must use a complete mecate rein, which must include a tie-rein. Absolutely no rigid material will be permitted under the jaws, regardless of how padded or covered. Horse hair bosals are prohibited. This rule does not refer to a mechanical hackamore.



Hackamores are permitted in any class on a junior horse five years old and under. A hackamore includes a bosal rounded in shape and constructed of braided rawhide or leather and must have flexible non-metallic core attached to a suitable headstall. No other material of any kind is to be used in conjunction with a bosal, i.e. plastic, resin, glue,

steel, metal or chains (Exception: smooth plastic electrical tape is acceptable if applied in a smooth, untwisted manner). There must be approximately ½” between the nose and the bosal. The bosal will be no larger than ¾” in diameter at the cheek and will flex easily. Attached reins may be of hair, rope or leather.



← These two wraps are ILLEGAL.



*Discussion: Smooth plastic electrical tape slides over the jaws of the horse with very little friction or “bite”, thereby making the hackamore comfortable for the horse. Latex or bandage material “grabs” the skin and hair making hackamore too severe. Sheepskin as it gets matted down and stiff from sweat can also become severe.*

↑ This wrap is legal.



Determining flexibility of the bosal core can be seen in this illustration. Whether or not the core is non-metallic can be more difficult to determine, as not all metals can be detected with a magnet. When checking bosals for flexibility, safety is the first criteria – ask the rider to dismount and drop the bosal if necessary.

## CLASSIC SNAFFLES & BITS



**Example:**  
**Various double bridle bits**  
**Bridoons:**

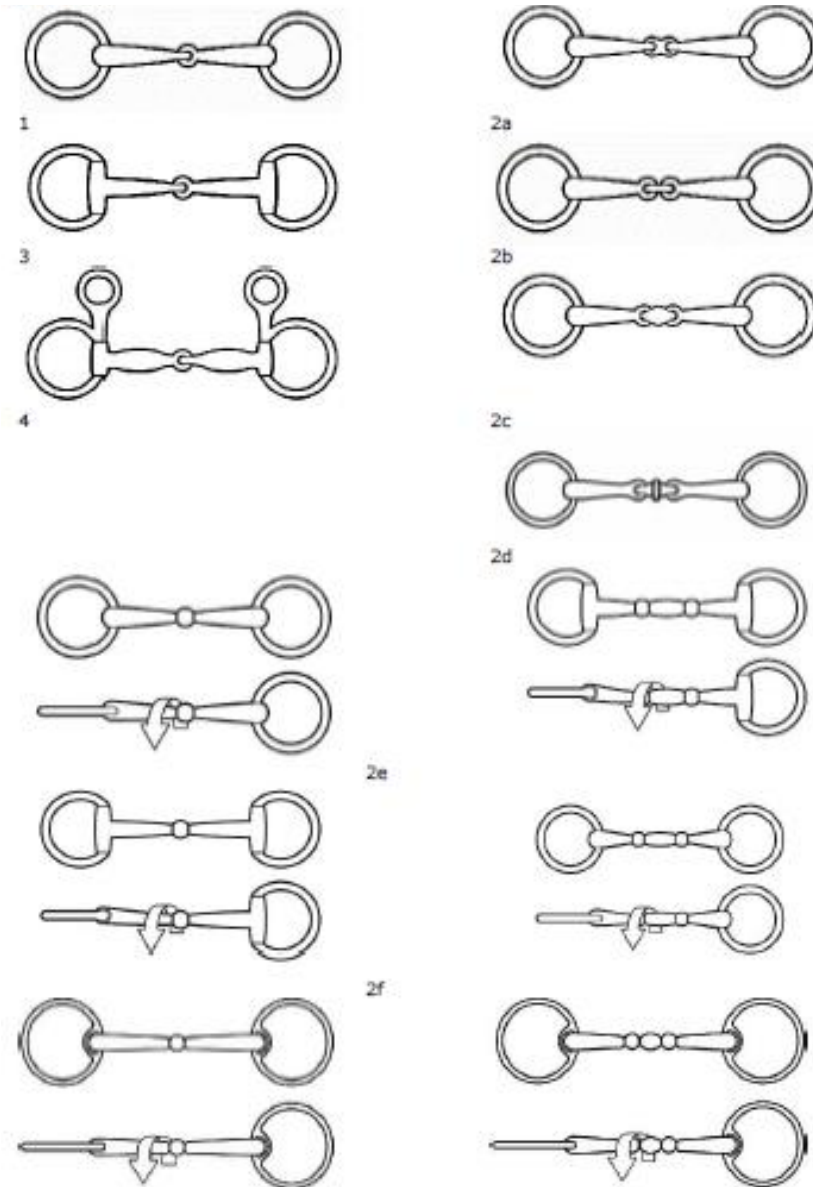

**Curbs:**

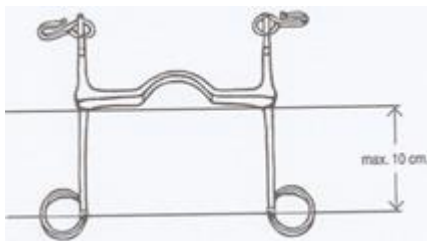
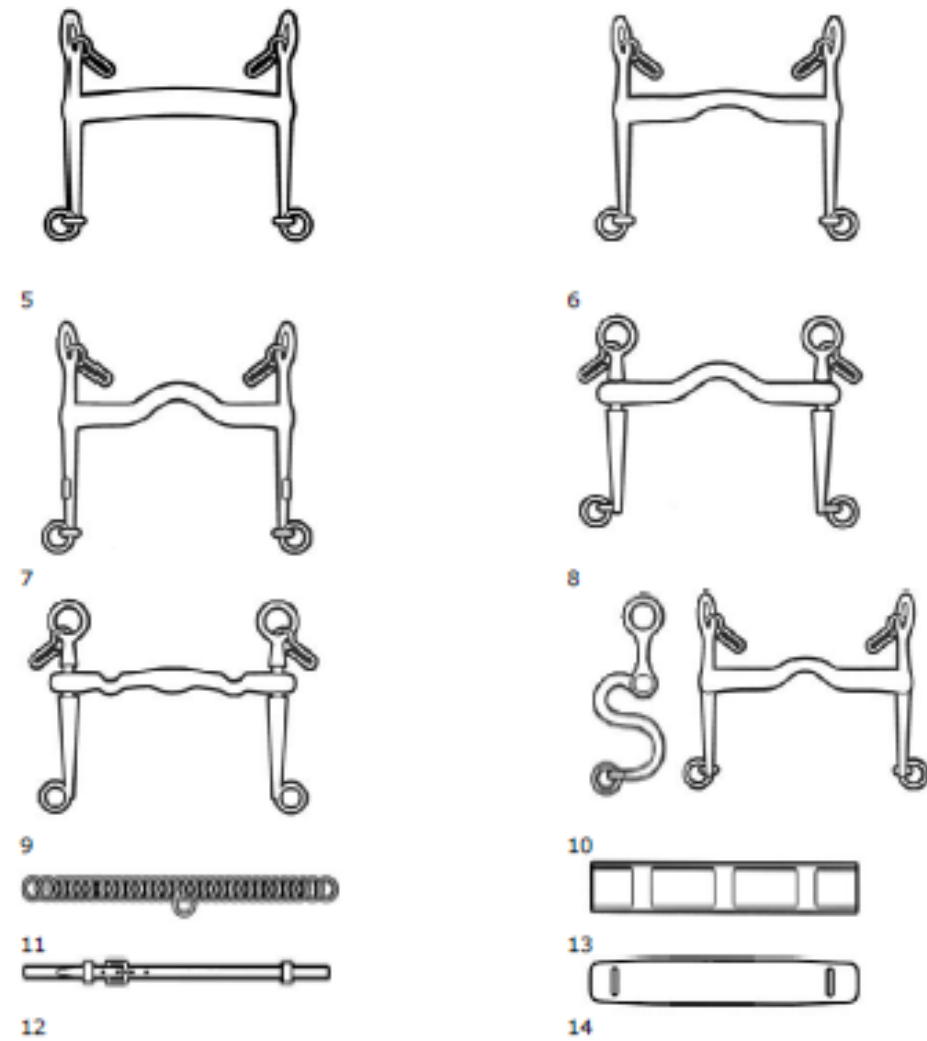

Correct bit measurement. The lever arm of the curb bit must not exceed 0 cm (length below the mouthpiece). If the curb has a sliding mouthpiece, the lever arm of the curb bit below the mouthpiece must not measure more than 10 cm when the mouthpiece is at the uppermost position.

**Permitted nosebands and bridles (nosebands are compulsory)**

1. Dropped noseband



2. Cavesson noseband



3. Flash noseband



4. Mexican (crossed figure-8) noseband

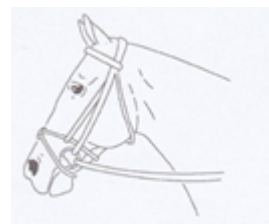

1, 3 and 4: These nosebands are not permitted when a double bridle is used.



Double bridle with cavesson noseband, bridoon bit and curb with curb chain



Combined noseband (no thruatlash). Permitted for use in at any level and in warm-up with either a snaffle bit or double bridle, as appropriate for the level. When used as a double bridle, the lower strap of the noseband (flah attachment pictured with the snaffle) is not permitted.



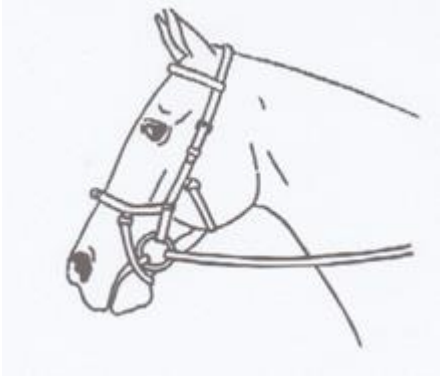

Micklem Bridle. Permitted for use at any level where snaffles are permitted. Not permitted for use as a double bridle. Bit clips may not be used with this bridle.

### Classic prohibited bits

Bits of any style (pelham, snaffle, kimberwick) featuring mouthpieces with cathedrals, donuts, prongs, edges or rough, sharp material shall be cause for elimination. Square stock, metal wrapped, or polo bits shall be cause for elimination. If a curb bit is used, the curb chain must be at least 1/2" (15mm) in width and lie flat against the jaw of the horse.

### Pelham - only allowed in Hunter Pleasure:



**Various bridle bits**

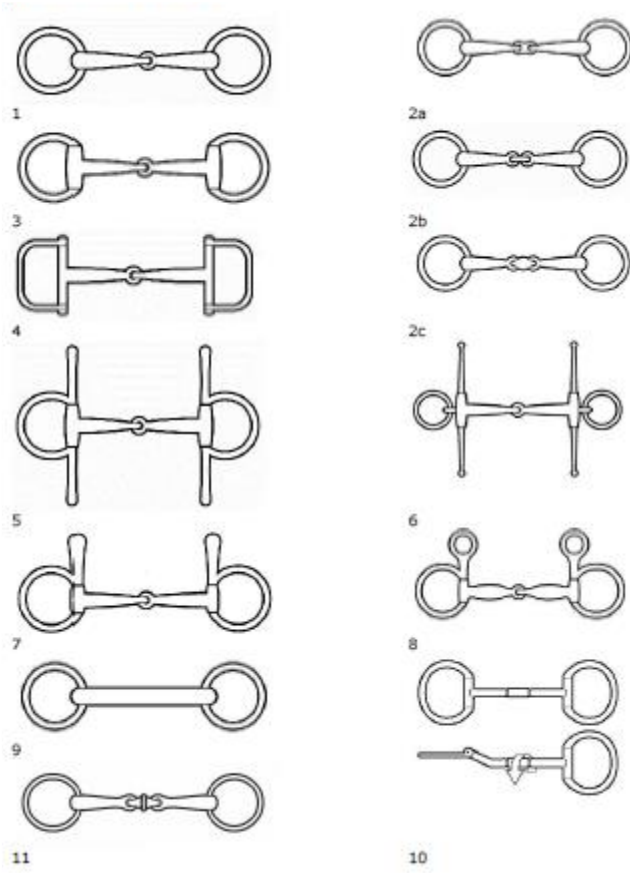

**Rotary bit**

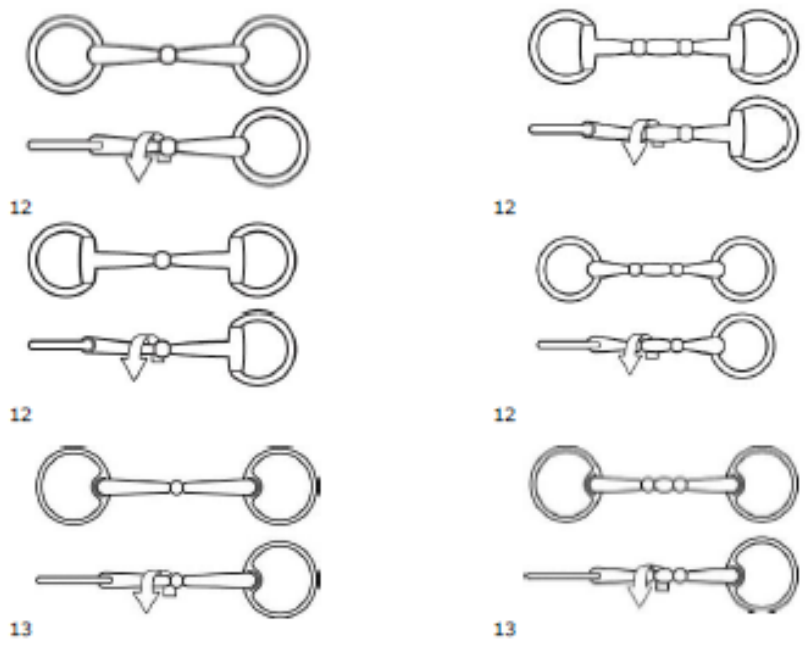

### Examples for Side Saddles:

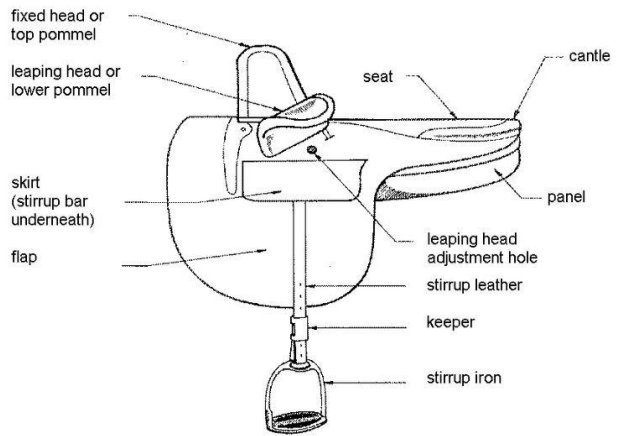
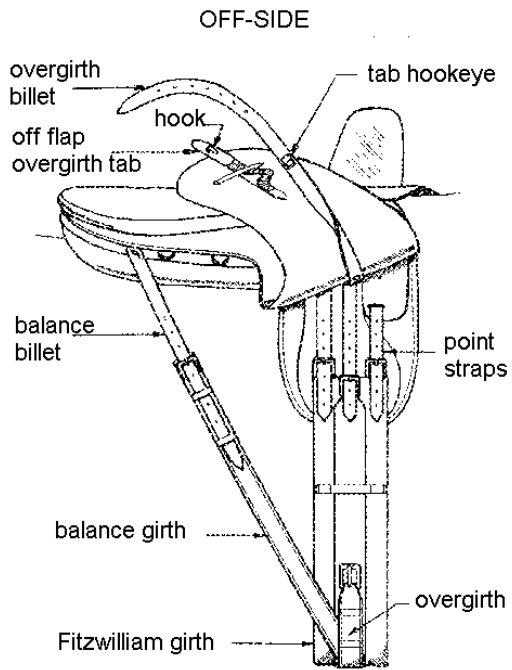

## Buggy & Cart allowed in Pleasure Driving:

**Formal Driving Buggy**



**Pleasure Driving Cart**



**Formal Driving Buggy (example):**



**Pleasure Driving Cart with overcheck (example):**



**Pleasure Driving Cart with sidecheck (example):**



**Bits, Bridles & Harness allowed in Pleasure Driving:**



**Driving harness with overcheck (example):**



